

# International Utility Dog Regulations (FCI-IGP)

for the  
international utility dog trial  
international tracking dog trial  
international companion dog trial  
international article search trial  
international endurance trial

of the FCI



Executed by order of the FCI Utility Dogs Commission:

Robert Markschläger

Klaus Jürgen Glüh

Igor Lengvarsky

Lene Carlson

Sharon Ronen

Hari Arcon

Gerard Besselink

Clemente Grosso

Frans Jansen

Roar Kjonstad

***These Rules were approved by the FCI General Committee on September 03<sup>rd</sup>, 2024  
They are effective from January 1<sup>st</sup>, 2025***



## Preamble

For more than 35.000 years, the dog has been the companion of mankind. Through the domestication of the dog, a close social relationship was formed with mankind and is in some respects dependent on him. This dependency creates a responsibility on the part of man to ensure the well-being of the dog. To keep his physical needs as well as the psychological health of the dog is top priority. It is imperative then that the dog be handled in a fair, orderly and humane way which considers its character and unique features that developed during evolution as a member of the order Carnivora and family Canidae. Dogs are a social species which needs to live in a group while at the same time keeping clear order and boundaries while maintaining cooperation and regular teamwork. Therefore, it's our duty to take care of his physical needs (proper nutrition, water and veterinary care) and ensure he gets exercise. It is also important to work with him as a team to fulfil its mental needs and drives .

During history, the dog has had various jobs to help man. Those jobs provided fulfilment for the dog's mental needs and drives. In the modern-day world, many of these duties have been relegated to technology. For this reason, the dog owner has the responsibility to ensure that the dog has other activities due to the loss of past jobs as well as adequate exercise and activities that offer close contact to people, and the possibility to express their natural instincts and drives. Under this point of view the companion test, the versatility test for the utility dog, the tracking test, and the article search test need to be factored in. The dog should be occupied according to his abilities and capabilities. Besides adequate exercise, he should have intense work with activities that take into consideration his learning ability, his exercise requirements as well as his other abilities. The various forms of dog sport provide these excellent venues. Dogs that do not have enough activities can experience ongoing frustration and resulting behavioural problems that may lead to public complaints.

A person who trains or does sport with his dog must undertake a method of careful training with the goal of achieving the best possible harmony between himself and the dog. The goal of all training is to convey to the dog what it is we want him to do in such a way that he can understand. The harmonious relationship between man and his dog, regardless of the dog sport one does, is the basis for all activities. To achieve harmony, it is important to honestly look at your dog and understand its abilities. It remains the ethical responsibility of man to raise and adequately train the dog regardless of the breed. To achieve the best upbringing, training or training effect, it is important that the dog shows motivation and willingness to cooperate with its handler. **Training** a dog for dog sport must be oriented to its capabilities, its spirit, and its willingness.

Influencing the dog's training capabilities using medication or animal cruelty must be avoided under all circumstances.

To achieve harmony, it is important to honestly look at your dog and understand his abilities. It remains the ethical responsibility of man to raise and adequately train the dog regardless of the breed. To achieve the best upbringing, training or training effect, it is important that the dog shows motivation and willingness to cooperate with his handler. Using a dog for dog sport must be oriented to his capabilities, his competitive spirit, and his willingness. Influencing the dog's training capabilities using medication or animal cruelty must be avoided under all circumstances.

## General abbreviations

FCI	Fédération Cynologique Internationale
IGP	International Utility Dog trial regulations
NPO	National Utility Dog Trial regulations
<b>FCI-NCO</b>	<b>FCI National Canine Organization</b>
TS	Trial Secretary
TD	Training Degree
TJ	Trial Judge
BP	Basic Position
TR	Trial Regulations
JI	Judge Instruction
VC	Verbal Command
CS	Chief Steward
HL	Helper
DH	Dog Handler
TL	Track Layer

**Validity:**

These Regulations are effective from 2025 They were drawn up by the FCI Utility Dogs Commission and were approved and confirmed by the FCI General Committee on 08.09 2024

As soon as this trial ruling takes effect, all previous rules lose their validity.

The regulations were written in the English language and approved by the Commission. In case of uncertainty, the English text takes precedence over other language translations.

These IGP regulations are valid for all FCI members and contract partners. All international trial events in terms of training and competitions are subject to these regulations.

**Table of content**

<b>PREAMBLE .....</b>	<b>2</b>
GENERAL ABBREVIATIONS .....	2
<b>TABLE OF CONTENT .....</b>	<b>3</b>
<b>GENERAL INFORMATION: .....</b>	<b>5</b>
TRIAL SEASON .....	6
TRIAL ORGANIZATION/TRIAL SECRETARY .....	6
TRIAL SUPERVISION .....	6
PERFORMANCE JUDGES .....	7
PHASES PER DAY PER EXAMINATION LEVEL .....	7
EQUIPMENT AND CLOTHING OF PARTICIPANTS .....	7
TRIAL PARTICIPANTS .....	8
TRACKLAYERS .....	8
PERMISSION TO ENTER A TRIAL .....	8
ANTI-DOPING AND VACCINATION REGULATIONS .....	9
SOCIAL COMPATIBILITY .....	10
<b>PHYSICALLY CHALLENGED DOG HANDLER (DISABLED) .....</b>	<b>10</b>
COLLAR REQUIREMENT/CARRYING A LEASH .....	10
MUZZLE OBLIGATION .....	10
LIABILITY .....	11
AWARDS CEREMONY / TROPHIES .....	11
WORKING AWARD .....	11
SCOREBOOK .....	11
VERBAL COMMANDS .....	12
INTERNATIONAL RULES/SPECIAL RULES .....	12
FCI WORLD/EUROPEAN CHAMPIONSHIP .....	12
DISCIPLINARY RIGHTS .....	12
DISQUALIFICATION .....	12
TERMINATION .....	13
TEMPERAMENT EVALUATION .....	14
CONDUCTING THE IDENTITY CHECK .....	14
GUNSHOT-SURENESS .....	15
EVALUATION .....	15
BASIC REQUIREMENTS FOR ALL LEVELS OF ANY FCI-IGP TRIAL .....	16
<b>COMPANION DOG TRIALS WITH BEHAVIOR AND TRAFFIC PART. (FCI-BH/VT) .....</b>	<b>17</b>
GENERAL INFORMATION .....	17
TRIAL DESCRIPTION: COMPANION DOG TRIAL WITH TRAFFIC SAFETY PART .....	17
OBEDIENCE EXAMINATION ON THE TRAINING GROUND .....	17
<i>General provisions .....</i>	<i>17</i>
<i>Basic requirements: .....</i>	<i>17</i>
<i>Principles in the assessment of exercises .....</i>	<i>17</i>
<i>The dog's response to the verbal command .....</i>	<i>18</i>
<i>Additional verbal commands .....</i>	<i>18</i>
<i>Execution of the basic position .....</i>	<i>18</i>
<i>Build-up .....</i>	<i>18</i>
<i>Picking up / calling in of the dog .....</i>	<i>18</i>
<i>Praise .....</i>	<i>18</i>
<i>Report in .....</i>	<i>18</i>



<i>Start and ending of an exercise</i> .....	18
<i>Scheme of obedience exercises FCI-BH/VT</i> .....	19
<i>Start of the exercise:</i> .....	19
<i>Heeling on Leash</i> 30 points .....	19
<i>Sit exercise</i> 10 points .....	20
<i>Down with recall</i> 10 points .....	20
<i>Down under distraction</i> 10 points .....	20
EXAMINATION IN TRAFFIC .....	20
GENERAL INFORMATION.....	20
<b>INTERNATIONAL COMPANION DOG TESTS FCI-IBGH 1-3</b> .....	<b>22</b>
DISTRIBUTION AND VALUES OF THE EXERCISES IN THE INDIVIDUAL LEVELS .....	22
SPECIAL FEATURES IN FCI-IBGH 1 – 3 .....	22
SPECIAL FEATURES IN THE FCI-IBGH 3: .....	22
GENERAL EXPLANATIONS .....	23
SCHEME OF OBEDIENCE FCI-IBGH1 .....	25
SCHEME OF OBEDIENCE FCI-IBGH2 .....	25
SCHEME OF OBEDIENCE FCI-IBGH3 .....	26
EXERCISE DESCRIPTIONS .....	26
<b>INTERNATIONAL UTILITY DOG EXAMINATIONS (IGP 1-3)</b> .....	<b>32</b>
PHASE A - TRACKING .....	32
<i>General provisions</i> .....	32
<i>Trackable ground</i> .....	32
<i>Laying the track</i> .....	33
Articles .....	33
<i>Indicating of the articles</i> .....	33
<i>Tracking leash</i> .....	34
<i>Report in / Report out</i> .....	35
<i>Working the Track</i> .....	35
Corners .....	35
<i>Praise/Encouragement</i> .....	36
<i>Termination/Disqualifications</i> .....	36
<i>Evaluation of the tracking performance:</i> .....	37
<i>Assessment:</i> .....	37
<i>Tracking forms</i> .....	38
<i>Laying the corners:</i> .....	39
<i>Laying the articles</i> .....	39
PHASE B - OBEDIENCE .....	40
<i>General explanations</i> .....	40
<i>Verbal command (vc)</i> .....	40
<i>Reporting in</i> .....	41
<i>Start and end of an exercise</i> .....	41
<i>Execution Basic of the position</i> .....	41
<i>Development / build up</i> .....	41
<i>Pick-up / call in the dog</i> .....	41
Praise .....	41
<i>Time intervals in each stage</i> .....	42
<i>Position error</i> .....	42
Retrieve .....	42
Hurdle .....	42
Scaling wall .....	42
<i>Primary and secondary elements in the assessment</i> .....	43
<i>Scheme of obedience exercises FCI-IGP</i> .....	43
<i>Exercise descriptions:</i> .....	43
PHASE C - PROTECTION - (FCI-IGP-1-3) .....	50
<i>General provisions:</i> .....	50
<i>Examination levels FCI-IGP-1 to IGP-3 (exercises and point allocation)</i> .....	52
<i>Exercise descriptions:</i> .....	52
HELPER REGULATIONS.....	60



<b>ADDITIONAL EXAMINATIONS .....</b>	<b>63</b>
TRACKING 1 – 3 (FPR 1 – 3) .....	63
OBEDIENCE 1 – 3 (UPR 1 – 3) .....	63
PROTECTION 1 – 3 (SPR 1 – 3) .....	63
WORKING DOG TEST 1 - 3 (GPR 1-3) .....	63
<b>FCI -IGP TRACKING DOG EXAMINATIONS.....</b>	<b>64</b>
GENERAL PROVISIONS .....	64
<i>FCI-IGP-FH</i> .....	64
<i>Trackable ground</i> .....	65
<i>Laying the track</i> .....	65
<i>Cross tracks in FCI-IFH2 and FCI-IFH3 levels</i> .....	65
<i>Instruction</i> .....	65
<i>Articles</i> .....	65
<i>Indicating of the articles</i> .....	66
<i>Tracking leash</i> .....	67
<i>Report in/ Report out</i> .....	67
<i>Working the Track</i> .....	67
<i>Corners</i> .....	68
<i>Ending the track in all levels</i> .....	68
<i>Praise/ Encouragement</i> .....	68
<i>Termination / Disqualification</i> .....	68
<i>Evaluation of the tracking performance:</i> .....	69
<i>Assessment</i> .....	69
TRACK SHAPES.....	70
LAYING THE CORNERS .....	72
LAYING THE ARTICLES .....	72
<b>FCI-ARTICLE SEARCH 1-3 .....</b>	<b>74</b>
TRIAL LEVELS FOR THE FCI-ARTICLE SEARCH .....	74
GENERAL REQUIREMENTS: .....	74
<i>Type of area for the search/indication work:</i> .....	74
<i>Articles</i> .....	74
<i>Reporting in</i> .....	75
<i>Execution of the trial in all levels</i> .....	75
<i>Behavior at the articles</i> .....	75
<i>Evaluation criteria for all 3 levels:</i> .....	76
<b>THE ENDURANCE TRIAL .....</b>	<b>77</b>
<b>DIAGRAMS .....</b>	<b>78</b>

## General information:

### Trial events and competitions should serve two purposes.

1. After passing an exam, the individual dog should receive recognition for its' particular purpose.
2. Contribute to the **overall mental health**, fitness, and work ethic of the dog.

The National Organization (FCI-NCO) is encouraged to promote the International Utility Dogs Regulations (FCI-IGP). Especially international competitions should be conducted under the International FCI Utility Dogs Regulations concept. All trials and competitions are subject to proper sportsmanship regarding the conduct of the participants. These regulations are binding. All participants must meet the same work performance requirements. The trials and competitions are to be made public by advertising the place and starting time to the members.

Trials Exams, events and competitions must contain complete trial levels or complete individual phases of the respective trial levels. Only a completed trial level passed in an event will count as a title. The titles must be accepted by all FCI member countries.



Every trial level can be repeated as frequently much as desired. The trial levels must be completed in order (levels 1 – 2 – 3) The dog can only be shown in the next level after successfully passing the previous level with a minimum rating of satisfactory in each phase (70%). The dog must be shown in the highest passed level. Exceptions: If the team starts out of competition or does not take part in qualifications, the trial level can be chosen freely.

### **Trial Season**

Trials may be conducted all year long if weather conditions are conducive and the well-being of both handler and dog are not at risk. Otherwise, the trial cannot be held. This is the sole decision made by the trial Judge. The individual national organization can impose restrictions regarding the trial season for their area.

### **Trial Days**

#### **Weekends and Holidays**

Trial days are generally on the weekend as well as legal holidays. However, the national organizations or trial associations that are authorized to issue trial permits can determine trial days that deviate from this recommendation, either for all trial levels or for individual trial levels. It is possible to trial for the FCI-BH/VT or BH/VT (NPO) and the FCI-IGP-1/ FCI-IFH-1 trials in tandem with a two-day trial at one or 2 different clubs. A waiting time between the FCI-BH/VT or BH/VT (NPO) and FCI-IGP-1, FCI-FPr, FCI-UPr, FCI-SPr, FCI-IAD, FCI-IFH-1, FCI-IBGH-1, FCI-StbPr. 1 does not exist. A dog can only take part in one trial a day. Participants who plan on trialing their dogs for FCI-IGP-1 or FCI-IFH-1 may start on one day for the FCI-BH/VT or BH/VT (NPO) and then on the next day they may take part in an examination for FCI-IGP-1 or FCI-IFH-1. This may not cause "overage" in the number of participants. Clubs must be attentive to the rules about authorizing the trial and to the regulations related the deadlines to protect the exam, issued by the national canine organizations.

### **Holiday regulations**

On holidays the above information can be followed.

Exception: The holiday regulations of the countries must be acknowledged.

### **Trial Organization/Trial Secretary**

The trial secretary is responsible for organizing the trial. He/she finalizes and supervises all of the steps required to prepare and conduct a trial. He/she must guarantee the orderly execution of the trial and must be at the judge's disposal for the duration of the trial.

The trial secretary may not show a dog or accept other duties. He/she is responsible for:

Obtaining all necessary trial permits / trial documents

Locating suitable tracking fields for all examination levels according to the rules

Coordinating with the property owners of the tracking fields or park ranger (make arrangements with landowners regarding tracking fields/ areas.)

Having experienced volunteers available such as helpers for protection, tracklayers, group, etc.

Obtaining the trial authorization

Make available the required equipment and proper protection gear for the helper.

Make available the written forms such as judges trial sheets, trial lists for all levels

Have available the scorebooks, pedigrees, vaccination certificates and if necessary, proof of insurance. The trial secretary must bring to the judge's attention possible exclusion of an examiner in the event of unsportsmanlike conduct or violations of an animal welfare law, if this did not happen during the presentation of his dog on the trial field and the acting judge therefore has no knowledge of it. The trial secretary must inform the judge about the situation and together they will make the final decision.

A minimum of three days in advance, the trial secretary must inform the judge the location, start times, directions, type of trial and number of dogs entered. Failure to provide this information can result in the judge declining to officiate.

The trial authorization is to be provided to the judge prior to the start of the examination.

### **Trial Supervision**

FCI-NCOs are entitled to supervise their organization's trials. The FCI-NCO can assign a knowledgeable person to oversee an exam to ensure that the exam is conducted in accordance with the regulations as stated in the 2025 FCI-IGP Regulations.



### Performance Judges

Judges who are authorized for the different phases of FCI-IGP trials can be selected and invited by the hosting club or appointed by the FCI-NCO.

Regarding world championships, the judges will, with the approval of the FCI-NCO, be appointed by the FCI Utility Dogs Commission. The number of judges invited for a trial or event is up to the hosting club. However, a judge may judge a maximum of 36 individual phases per day. At FCI-IGP World Championships or national championships, this number can be exceeded with the approval of the national organisation (FCI-LAO).

Several judges may also be used per discipline. Judges are not permitted to judge dogs that are owned by him/her or are in his/her possession, dogs whose owners reside with him/her, or dogs that are owned by another person of the same household.

Exceptions to this rule can be made if they are **super-regional** events and the judge has been assigned by the NCO or a body that was made responsible for the organisation. If a national or regional organization intends to appoint a foreign judge, this must be done by means of a judge's release between the two FCI-NCOs.

A judge is not permitted to handle a dog in a trial in which he/she is officiating.

The judge is not permitted to disturb or influence the work of the dog through his behaviour. The way the exercises must be shown is described in the FCI International Utility Dogs Regulations and must be strictly followed and may not be adapted. This counts for all disciplines.

The judge is responsible for the compliance and correct adherence to the governing rules. He/she is authorized to terminate the exam for failure of compliance of the rules and/or his/her instructions.

### Phases per day per examination level

FCI-Companion dog with traffic part (FCI-BH/VT) or BH/VT (NPO) FCI-BH/VT – BH/VT NPO	equivalent to 2 phases
FCI-Companion dog with traffic part (FCI-BH/VT) or BH/VT (NPO) with handler proficiency test	equivalent to 3 phases
FCI-FPr, FCI-UPr and FCI-SPr, 1-3	equivalent to 1 phase
FCI-GPr 1-3	equivalent to 2 phases
FCI-IBGH 1-3	equivalent to 1 phase
FCI-IFH-1	equivalent to 1 phase
FCI-IFH-2	equivalent to 2 phase
FCI-IGP-IFH 3 and FCI-IGP-IFH If a tracking coordinator instructs the tracklaying	equivalent to 3 phases equivalent to 2 phases
FCI-IGP 1 - 3	equivalent to 3 phases
FCI-Article search examination 1-3 / Article search 1-3	equivalent to 1 phase
FCI-Endurance Test	equivalent to 1 phase

For major events scheduled by the National Organization (FCI-NCO), special regulations can be established. The National Organization (FCI-NCO) submits a proposal to the FCI Utility Dogs Commission, who makes the final determination.

### Equipment and clothing of participants

The wearing of a tight/normally fitting vest (without protruding pockets and other subsequently attached objects) is permitted during trial. On the other hand, belly bags and so-called training aprons are not allowed. It is the responsibility of the National Organization or a Breed association to issue further regulations for super-regional events.



### Trial Participants

The trial participant must adhere to local and animal welfare laws, and exhibit appropriate behavior for the location, spectators, and other participants.

The trial participant must meet the entry deadline for the trial. The trial participant also agrees to pay the entry fee upon submission of the entry form. If the trial participant cannot participate for whatever reason, he/she must advise the trial secretary immediately.

The trial participant is required to provide their dog's vaccination certificate and uphold the animal rights guidelines. The trial participant must adhere to the instructions of the officiating judge as well as the trial secretary. The trial participant must present his/her dog in a sportsmanlike manner regardless of the results in any given phase and he/she is obliged to continue for the remaining phases of the trial.

The trial must have a minimum of 4 participants per trial day (four different handlers). The minimum number of participants per day may only be less if for FCI-BH/VT or BH/VT (NPO) trials, if these dogs pass and try for a further trial (FCI-IGP-1, FCI-IFH 1) at the same trial. A participant may only take part in one trial with the same dog. (A two-day trial is considered as one trial.)

A trial participant may enter a maximum of two dogs for an examination at a trial. A dog may only acquire one title within a trial. Exception: FCI-BH/VT or BH/VT (NPO) in conjunction with another level 1 (FCI-IGP) title.

Prerequisite for entering a trial is that owner and the trial participant belong to a club of the national organization which is recognized by the FCI. Exceptions to this can be determined by the FCI-NCO only for FCI-BH/VT or BH/VT (NPO) trials.

### Tracklayers

Tracklayers are bound by the described FCI-IGP regulations. Tracklayers are mandatory in trials/events in FCI-IGP2, FCI-IGP3, FCI-IFH2, FCI-IFH3 and FCI-IGP-IFH. At trials, events and championships, it is advised to use certificated tracklayers. The judge or the tracking coordinator will determine the course of the track depending on the existing terrain. The tracklayer receives instructions from the judge/ tracking coordinator. For the FCI-IFH1 (the handler), FCI-IFH-2, FCI-IFH-3 and FCI-IGP-FH, the tracklayer receives a track sketch from the judge or the tracking coordinator that includes terrain features (e.g., trees, wire poles, huts, etc.). The judge/tracking coordinator supervises the laying of the tracks and instructs the tracklayers. The tracks must be laid differently; corners and articles must not be at the same position or at equal distances for each track.

The scent pad of the track must be marked by a sign which is placed directly into the ground to the left of the scent pad. The tracklayer stays briefly at the scent pad and goes in natural stride with normal steps in the directed direction. When laying the track, the tracklayer will use a normal gait. The corners are also set in a normal gait, so that continuous track work must be possible. (See sketch on page.104). Help by the tracklayer by unnatural gait, scuffing or stomping is not permitted in the entire area of the track. Articles are to be placed on the track while walking and must not be placed within 20 paces before or after the corner. After placing the last article, the track layer must continue at least 10 paces in a forward direction. From FCI-IGP2 on, the handler and dog are not allowed to watch the track being laid. The order of the participants is determined with a draw after laying the tracks/cross tracks in the presence of the judge or an appointed person.

### Permission to enter a trial

On the day of the trial, the dog must have met the minimum age required. No exceptions are permitted. The dog is required to have passed the FCI-BH/VT or BH/VT (NPO) in accordance with the rules set forth by the national organization (FCI-NCO). The required age limit for the FCI-BH/VT or BH/VT (NPO) is to be set by the national organization but can never be under 12 months of age.

FCI-IBGH 1	FCI-BH/VT/BH/VT NPO	15 months
FCI-IBGH 2	FCI-IBGH 1	15 months
FCI-IBGH 3	FCI-IBGH 2 / FCI-Obedience 1 / FCI-IGP 1	15 months
FCI-IGP 1	FCI-BH/VT / BH/VT NPO	18 months
FCI-IGP 2	FCI-IGP 1	19 months





FCI-IGP 3	FCI-IGP 2	20 months
FCI-IFH 1	FCI-BH/VT /BH/VT NPO	18 months
FCI-IFH 2	FCI-IFH 1	19 months
FCI-IFH 3	FCI-IFH 2	20 months
FCI- IGP-IFH	FCI-IFH 3	20 months
FCI-FPr. 1-3	FCI-BH/VT /BH/VT NPO	15 months
FCI-UPr. 1-3	FCI-BH/VT /BH/VT NPO	15 months
FCI-GPr. 1-3	FCI-BH/VT /BH/VT NPO	18 months
FCI-SPr.1-3	FCI-BH/VT /BH/VT NPO	18 months
FCI-StöPr. 1	FCI-BH/VT /BH/VT NPO	15 months
FCI-StöPr. 2	FCI-StöPr. 1	15 months
FCI-StöPr. 3	FCI-StöPr. 2	15 months
FCI-IAD	FCI-BH/VT /BH/VT NPO	16 months

If a dog has successfully completed the FCI-IGP1 or a trial from the dog sport Obedience, it must start in the FCI-IBgH3 level.

The exercises for the FCI-FPr 1-3 take place according to the FCI-IGP 1-3 rules for Phase A, the exercises for FCI-UPr 1-3 take place according to the FCI-IGP 1-3 rules for Phase B, the exercises for FCI-SPr 1-3 take place according to the FCI-IGP rules for Phase C. The exercises for the FCI-Gpr 1-3 take place according to the FCI-IGP 1-3 obedience and protection rules for Phases B&C. These exercises can be examined as single phases, without obtaining an official certificate (working title).

Events with only a protection phase are not permitted.

All registered dogs, regardless of size, breed or heritage may participate at an exam. It is up to the judge to decide if the dog is in physical condition to complete the requirements of the regulations.

The handler can choose the level of these trials he/she will start without a previously passed lower level. However, prior successful completion of a FCI-BH/VT or BH/VT(NPO) is mandatory.

Females in heat may participate at all trial events but must be shown separately from the other dogs. In phase A, they will track with the other dogs entered in the trial, but in the remaining phase/phases they will be shown at the end after all other dogs have completed the trial/event. In the endurance trial the female in heat must start last and at a clear distance so as not to disturb the other dogs. This distance is to be decided by the judge. Pregnant bitches may only take part in FCI-BH/VT, all FCI- FH, FCI-Article Search and FCI-Endurance trials up to and including the 27th day after mating.

After the 27th day after mating the bitch is allowed to participate only if a veterinary confirmation is presented that the dog is not pregnant.

A separate publication from the FCI and/or the national organization (FCI-NCO) provides information on restricted periods for pregnant and lactating bitches.

Sick dogs and dogs suspected of contagious disease are excluded from all events. In case of doubt, the veterinarian will make the final decision.

### **Anti-doping and vaccination regulations**

#### **Doping and other inappropriate measures.**

Participating of ill or injured dogs is not permitted. Furthermore the dog must not be affected in any forbidden way, i.e. been subjected to measures aimed at inappropriately altering their appearance, performance or reactions/character, or intended to conceal signs of injury or illness.

It is the obligation of the person responsible for the dog to ascertain how a specific treatment (for example



waiting periods following medical treatment, etc) or other measures may affect the eligibility of the dog to participate. (Also see FCI International Guideline about dog doping)

The organizer should well in advance of the competition make information available about regulations regarding treatments and measures that are inappropriate.

A doping test can be performed. If the NCO or the organizer for the competition decides to take a sample for the investigation of possible doping or other inappropriate measures, the person responsible for the dog is obliged to make the dog in question available for testing and for any further examination resulting from the test.

### **Vaccination regulations**

Participating dogs has to have vaccinations according to the national regulations of the NCO, proven by dog passport/vaccination certificate

### **Social compatibility**

In cases of dog aggression, immediate disqualification (DQ) occurs.

A dog who, at any time during the competition (before, during or after their own performance) bites a person or another dog, tries to bite, attack, or attempt to attack, is disqualified from the trial/competition. All points are withdrawn, and the dog disqualified (DQ), even if the dog has completed all 3 phases. In a two-day event, the disqualification also extends to the second day so that the dog cannot start or continue in the trial. Before the dog is allowed to enter another trial or event, the dog owner/handler must prove that the team (handler and dog) has again successfully participated in a FCI-BH/VT or BH/VT (NPO) trial.

The disqualification must be entered by the judge in all the performance records/scorebooks, pedigrees known to the judge and must be signed by the judge.

**Entry: "Disqualification due to dog aggression, dog must be presented again in an FCI-BH/VT or BH/VT (NPO) with behavioral test. "**

In such a case, the judge must make a report, with case description, to the National Organization.

Depending on the case, the National Organizations can then also order further clarifications, especially if a renewed completion of a BH/VT can pose a risk to humans or animals. In the event of a new screening due to a lack of social compatibility, the officiating judge must be informed in advance by the National Organization. If the judge considers it appropriate, he can make appropriate adjustments to the system for safety, so that there is no risk. In such a case, the inspection must be carried out together with a so called "white dog" dog.

The attacked dog is, even if this dog responds and defends itself, not to be sanctioned.

### **Physically challenged dog handler (Disabled)**

If a handler cannot carry out a part of an exercise correctly due to a physical handicap, he/she must inform the judge before the start of the trial. If due to a physical handicap the handler cannot present the dog on the left side of the handler, the dog may be presented in the same way on the right side. The National Canine Organizations (FCI-NCO) may also allow further extensions.

### **Collar requirement/Carrying a leash**

Required is a single row, loose fitting large link chain collar. In countries where required by law, the collar must be provided with a stop. The dog must wear the mentioned collar for the duration of the trial. During the FCI-BH/VT or BH/VT (NPO) other types of collars such as leather collar, fabric collar or chest harness are allowed. For the FCI-IBGH 1 to 3, similar collars to the FCI-BH/VT or BH/VT (NPO) may be used except for the chest harness. For the tracking phase, a dog may wear a tracking harness, a Böttger or a vest in addition to the required loose-fitting large link chain collar. A leash must be carried for the duration of the trial. It may be out of sight or worn by the handler with the clip on the side opposite to the dog's working side.

### **Muzzle obligation**

In countries where required by law, the handlers must show their dogs in the FCI-BH/VT or BH/VT (NPO) trials with a muzzle. In countries where handlers are not bounded by law, dog handlers must show the dog without a muzzle.



## Liability

The owner of the dog is liable for any personal injury or material damage caused by his/her dog. Therefore, he/she must have adequate coverage for such cases. In the event of an accident during the trial/competition, the handler is liable for himself / herself and his/her dog. The handler must agree to the instructions of the judge and the organizing club and thereby executes of his/her own free will the instructions at his/her own risk.

## Awards Ceremony / trophies

Award ceremonies are to be held separately and after all the various examination phases. The award ceremony is part of the trial. The dog must be guided by the handler at the award ceremony without wearing or providing a motivational object.

With rare exception, all participants and their participating dog must be present at the awards ceremony. The trial / competition official ends after all participants have finished their trial /competition and when after the closing ceremony and the handing out of the scorebooks is done.

If the same number of points are awarded to more than one dog in the FCI-IGP, level 1 -3, the result (highest score) of the phase C is the deciding factor. If the points awarded here are the same, then phase B is the deciding factor. If points result equally for all three phases, then all dogs receive the same rating.

If the same number of points are awarded to more than one dog in the **FCI-IGP-FH**, the result (highest score) in the single track is the deciding factor. If the points awarded in both tracks are the same, then all dogs receive the same rating.

In all other trials such as companion dog trials and article search trials, the same placements are awarded in the event of a tie. Successfully passed trials are evaluated before those that were not successful / failed.

The start of the trial is specified in the trial approval and ends with the return of the scorebook. The award ceremony is part of the trial. The dog must be guided by the handler at the award ceremony without wearing or providing a motivational object.

**Generally**, all participants, with their participating dog, must be present at the awards ceremony.

## Working Award

FCI-CACIT (Certificat d'Aptitude au Championnat International de Travail de la FCI) The FCI-CACIT and the Reserve FCI-CACIT are at stake at FCI-sanctioned competitions, in the highest levels (FCI-IGP-3, FCI-IFH-3 or FCI-IGP-Special and at the FCI-IGP /FCI-IGP-FH WC's). The proposals for offering FCI-CACIT or Reserve-FCI-CACIT are confirmed by the FCI Head Office after receipt of the results. The regulations for the FCI International Championship apply. All FCI National Organizations (FCI-NCO) must be invited to an FCI-CACIT event. A minimum of 2 international FCI GP judges must be invited with at least one judge being from another National Organization (FCI-NCO). The awards are granted upon approval by the judges. The FCI-CACIT and Reserve FCI-CACIT can only be awarded to dogs under the following conditions:

- The minimum show rating "very good" has been achieved at a conformation show.
- At the competition the minimum rating of "very good" was received. The FCI-CACIT is not automatically linked to the achieved rating.
- The dog must belong to group 1, 2 or 3 of the Breeds Nomenclature of the FCI which are subject to a working trial (utility and tracking dogs).

**Per event**, there is only to be awarded one (1) FCI-CACIT and one (1) reserve FCI-CACIT per breed. The national award CACT will be regulated by the National Organizations (**FCI-NCO**).

## Scorebook

An FCI recognized scorebook is mandatory for every participating dog. Issuing of the scorebook is done according to the instructions of the handler's corresponding National Cynological Organization. The scorebook must be issued by the National Cynological organization in whose studbook the dog is entered. The dog must be registered in the studbook where the owner resides. In case of a change of ownership, the scorebook that has already been issued will be continued. The new owner must be added and, if necessary, the studbook number of the new country must also be added. Important to note, only one FCI recognized scorebook may be issued per dog. This is the responsibility of the issuing organization. Only in a country where the National Kennel Club as well as the breed club issues a scorebook/scorecard, the dog can have both.



The trial results must under all circumstances be recorded in the scorebook(s)/ scorecards by the judge as well as the trial secretary who is to double check the entry and both must sign the scorebook.

The following scorebook entries are required: Members number, trial place and date, name and breed of the dog, identification of the dog (tattoo nr./chip nr.), name and address of the owner of the dog, entry of the total points in Phases A, B and C, qualifications and name of the judge and trial secretary and their signature.

National Cynological Organizations can also issue licenses that replace a scorebook. In this case however, it must be ensured that the trial results are recorded in a central performance database.

### **Verbal commands**

The verbal commands in the FCI-IGP trial regulations are considered suggestions. Verbal commands are given as normal short-spoken words and must always be the same for the same task. Very long spoken words are rated as help. When recalling the dog, the name of the dog can be used instead of the command to recall. During the blind search, the name of the dog can be mentioned in addition to the recall command. In all other situations, the name of the dog in conjunction with any other command is considered a double command.

The National Cynological Organization may make provision for the use of only the national language commands, which are provided by the National Cynological Organization and must be published in their rulebook. It is, however, permissible in any case is that the commands may be given in the mother tongue of the handler.

### **International rules/Special rules**

The National Cynological Organizations of the FCI (**FCI-NCO**) are authorized to enhance their general regulations, e.g. entry requirements, veterinarian requirements, animal rights, medical regulations or any rules governed through the country. Commands may be given in the country's language. The National Cynological Organizations of the FCI (**FCI-LAO**) are also entitled to extend the general provisions for their country or to make appropriate adjustments. Such adjustments must be reported to the FCI Utility Dogs Commission and confirmed by them before they become effective.

### **FCI World/European Championship**

During the various world championships of the FCI, the specifications for the organization of the FCI for this world championships are valid. The publishing and revision of said specifications are the duty of the Utility Dogs Commission.

### **Disciplinary rights**

The trial secretary is responsible to guarantee order and the safety in the entire trial area.

The officiating judge is authorized to terminate the exam if order and safety are compromised in any way. Violations by the handler against the prevailing rules, trial rules, animal protection laws and cultural customs will lead to a disqualification and must be reported by the officiating judge to the National Cynological Organization.

The officiating judge's evaluations of the performance are final and may not be contested. Public criticism of a judge's evaluations may result in dismissal from the trial grounds and further disciplinary action may follow. Justifiable objections may be made in cases where the judge has violated the FCI-IGP regulations but not against his evaluations.

Any such objections must be made in writing and addressed to the relevant authority and lodged with the show holding organization and signed by the complainant. Objections must be lodged within 8 days after the closing of the exam/event. Acceptance of an objection does not imply that the judge's evaluation will be revised. Video recordings for evidential purposes are not permitted. The provisions of the disciplinary regulations of the National Cynological Organizations (**FCI-NCO**) must be considered.

### **Disqualification**

All points awarded up to the point of disqualification (DQ) will be deleted. No points or ratings will be entered into the scorebook. There will not be an evaluation. It is not permitted to show the dog in the other phases. In the scorebook the reason for the disqualification must be written and signed by the judge.



Reason for disqualification	Consequence
Dog picks up the article on the track and will not or cannot release it. The dog leaves the field and does not return after three commands to return. The dog is not under control of the handler (e.g., side/back transport); the dog is not under control after three commands (one allowed and two additional or only by active action of the handler). The dog bites (not bumps) the helper anywhere on the helper's body other than the protective sleeve provided for the grip. Dog is in protection phase targeting another person (judge, steward etc.) than the helper.	Disqualification for disobedience
The dog is not neutral during the identity check.	Disqualification due to unsocial behavior
Unsportsmanlike behavior of the handler, for example, transport of motivation objects and/or food.  Acts against the FCI-IGP, animal protection regulations or contrary to good manners. Suspected attempt of fraudulent intent by use of prohibited training aids.  Not obeying the judge's instruction	Disqualification for unsportsmanlike behavior  Disqualification for unsportsmanlike behavior  Disqualification for unsportsmanlike behavior.

### Termination

In the case of a termination, all points awarded up to then stay awarded, also the points of the phases that have been completed so far. The points reached up to the point of termination are entered in the scorebook. If the dog is terminated in phase C, phase C is to be evaluated with 0 points, the points reached in sections A and B are retained.

### Reasons for termination

- Dog is 3 times unsuccessfully started on the track or after indicating an article.
- Dog leaves track by more than one leash length.
- Dog is not at the end of the track in the given time.
- Dog chases game and will not resume tracking.
- The dog leaves the helper before the judge instructs the handler to leave the centre line and does not return to helper with one command or leaves the helper again.
- Dog fails in protection exercise.
- The dog leaves the helper before the judges instruction to approach the dog and / or the handler gives a command to make the dog remain (stay) with the helper
- The dog does not find the helper after three unsuccessful commands to direct the dog to the find blind.

### Termination due to illness/injury

If a dog presented for a trial is sick, this is to be handled in the following manner:

If the handler reports the situation after having completed a phase with a sick dog, the following remark must be added in the trial documents: "Termination due to illness". The points achieved will be retained but no rating will be awarded.



Note: A judge on his own initiative and even against the dog handler's opinion can terminate the performance, if he observes that the dog is sick or injured. The same must also apply if the dogs that are presented, are obviously not able to perform because of their age and thus from an animal welfare perspective. If the decision was made by the judge, there is no need for a document from the veterinarian. The following remark is then added in the trial documents: "Termination due to injury".

### Temperament Evaluation

The temperament test is to be conducted throughout the duration of the trial/event, including the awards ceremony. If a dog stands out with a temperament problem, then he/she cannot pass even though results up to that point were positive. If a dog fails the temperament test, it must be noted in the records. The dog must be disqualified (DQ).

The temperament test takes place prior to each FCI-IGP trial.

The test is to be conducted in a neutral place. In the selection of the place, there should be no close connection to the trial grounds or tracking fields.

Every dog is to be evaluated independently. A systematic evaluation is not permitted.

The timeframe should be such that the dog is not immediately to start tracking or go on the trial field. The dogs must be on a short leash (without tracking harness, etc.). The leash is to be held loose. The dog must be led under control.

As a minimum requirement however, there must be a short review by the judge of the behavior towards humans and dogs, as well as the chip control. It is up to the judge to determine the way the evaluation is to be conducted; there must not be extreme variations in the evaluation by the judges and the less a judge tries to make a point, the smoother and safer the exam will run. The evaluation is to be done in a normal everyday setting, the dog is not to be challenged, otherwise it would invoke a natural reaction. Unnatural stimuli are to be avoided. The chip/tattoo identity control is a mandatory part of the temperament exam.

If the judge identifies a temperament weakness, he/she must test it correctly and precisely (e.g., gun test). Repetitions are then permitted. If a dog shows behavioral deficiencies during the next part of the trial, even if it has passed the preliminary temperament test, the judge can exclude the dog from the trial and indicate "temperament/ behavior test not passed" in the scorebook.

The FCI-BH/VT or BH/VT (NPO) trial does not include the gun shots test. An FCI-BH/VT or BH/VT (NPO) dog is not allowed to be paired with dogs from the FCI-IGP levels because of the gun shots test. The FCI-BH/VT or BH/VT (NPO) or FCI-IBGH may be paired together as a group. In FCI-BH/VT or BH/VT (NPO) and FCI-IBGH, no gun shots are required.

### Results of the temperament test:

- Positive presentation = passed
- Dog is self-confident
- Dog is calm, secure, and attentive
- Dog is lively and attentive
- Dog is impartial and good-natured
- Borderline = requires special attention
- Dog is unsteady but not aggressive and is balanced throughout the trial
- Slightly agitated, but gets calmer throughout the trial

### Dogs that are not allowed to participate in the trial:

- Insecure and frightened, move away from a person
- Nervous, aggressive, dogs sounding an alarm, fear biters.
- Biting dogs

### Conducting the identity check

The identity control is a mandatory part of each trial. This can be done by either checking the tattoo number or using a chip reader for a microchipped dog. Dogs that do not have a tattoo number must be microchipped. The judge must note in their records that the identity check was carried out.

If tattoo numbers are not easily recognizable, the numbers that can be seen must be recorded. The tattoo number must coincide with the one entered on the pedigree and scorebook. If difficulties arise (e.g., unable to read a number), then a remark must be made accordingly.

Handlers /owners that had their dogs microchipped in a foreign country, or who have purchased a dog from another country, are responsible that the appropriate microchip reader is available.

If the microchip is not found by the judge, the judge instructs the handler to carry out the chip control himself. It is mandatory that the judge, or an appointed person, make a final check with the chip reader.

A dog whose identity cannot be established cannot participate in the examination/event.

### Gunshot-sureness

(In countries where the use of firearms is prohibited, a different sound test with a similar sound can also be carried out with a different device.)

#### What is the meaning of the term “gunshot-shy”?

Examples:

- The dog gets up and runs away.
- The dog shows a fear reaction.
- Runs under the same manner to his handler.
- Shows panic and fear and tries to leave the area or leaves the area.
- Shows panic and fear and runs wildly around.

During the evaluation, it must be determined if the behavior is due to a training fault or if the response is not related to the gunshot.

In dubious cases, the judge will determine if it is gun sensitivity by having the handler put the dog on leash. From a distance of about 15 paces, the judge will request additional shots be fired while the dog is held on a loose leash.

### Evaluation

The evaluation of the performance is noted with ratings (qualification) and points. The rating (qualification) and the corresponding points must reflect the quality of the respective exercise.

### Point table

Highest points	Excellent 96-100%	Very good 90-95,5%	Good 80-89,5%	Satisfactory 70-79,5%	Insufficient bis 69,5%
3	3	2.7	2.4	2,1	2.0 - 0
5	5.0	4.5 - 4.75	4.4 - 4.0	3.9 - 3.5	3.4 – 0
7	7.0 – 6.7	6.6 – 6.3	6.2 – 5.6	5.5 – 4.9	4.8 - 0
10	10.0	9.5 - 9.0	8.5 - 8.0	7.5 - 7.0	6.5 – 0
15	15.0 - 14.5	14.0 - 13.5	13.0 - 12.0	11.5 - 10.5	10.0 – 0
20	20.0 - 19.5	19.0 – 18.0	17.5 – 16.0	15.5 – 14.0	13.5 – 0
30	30.0 – 29.0	28.5 – 27.0	26.5 -24.0	23.5 – 21.0	20.5 – 0
60	60.0 – 58.0	57.5 – 54.0	53.5 – 48.0	47.5 – 42.0	41.5 – 0
70	70.0 – 66.5	66.0 – 63.0	62.5 – 56.0	55.5 – 49.0	48.5 – 0
100	100 – 96.0	95.5 – 90.0	89.5 – 80.0	79.5 – 70.0	69.5 – 0
200	200-192	191 -180	179 - 160	159 - 140	139 - 0



Awarded FCI-IGP1-3	Evaluation
286 - 300	Excellent
270 – 285	Very Good
240 – 269	Good
210 -- 239	Satisfactory
0 - 209	Insufficient

**Point table - Individual tests:**

During the evaluation of a particular phase only full points are to be awarded. However, with individual exercises, partial points can be given. If points are awarded with partial levels, the final result must be either rounded up or down.

**Basic requirements for all levels of any FCI-IGP trial****- Expressive behavior/self-confidence**

Particular attention is to be paid to expressive behavior by the dog during the judging and by awarding the respective score. The dogs must show that they want to do the required exercise for the handler and not show that they are being pressured to do it. Close observation of the entire dog such as facial expression, ear and tail position, tense muscles, unnatural movement, excessive breathing rate, excessive salivation or hectic behavior, etc., contribute to the evaluation. Negative reactions after the delivery of verbal commands leads to deductions.

- **Joyful, motivated work**  
The dog should show motivated work. The willingness to work and to show a performance is top priority
- **Concentration/attention**  
The dog must be concentrated on the handler during the entire routine without showing an extremely abnormal body or head posture.
- **Harmony of the team**  
The presentation should be harmonious. The dog must be able to follow the handler in a normal sequence of steps for a dog.
- **Technical correctness/position**  
In addition to expressive behavior and a harmonious performance, attention must be paid to a technically correct execution. The exercises should be performed clearly and according to their description.

**Acceptance/execution**

The dog should always accept the commands immediately and perform the exercises without delay.



## Companion Dog trials with behavior and traffic part. (FCI-BH/VT)

### General information

All handlers, if required by their NCO, who provide proof that they have already successfully passed the expert knowledge test analogous to the regulations of the national organizations, or those who present the official proof of expert knowledge are allowed. Dogs of all breeds and sizes are admitted. The age of admission is determined by the national organization (FCI-NCO) but may not be less than twelve months.

A national BH-VT (BH/VT NPO) is recognized if with the described obedience part, at a minimum the exercises listed in the examination part "Examination in Traffic" are included. There are no deadlines for taking the trial again, but it can only be taken once within a trial event (two-day examination). Each trial result must be entered in the transcript of records/scorebook regardless of the success of the trial.

### Trial description: Companion dog trial with traffic safety part.

During this trial, the focus must be on social compatibility and not on the technical execution of the obedience test. During the obedience part of this trial the judge will focus on the dog and evaluating basic obedience.

## Obedience examination on the training ground

### General provisions

#### Basic requirements:

- **Expressive behavior/self-confidence**  
When assessing and assigning the respective rating, extra attention must be paid to expressive behavior. The dog must show that it wants to do the required exercise for the handler and not that it must do it. Close observation of the entire dog including facial expression, ear and tail position, tense muscles, unnatural movement, excessive breathing rate, excessive salivation or hectic behavior, etc., will contribute to the evaluation. Negative reactions after the verbal commands or sound signals lead to deductions.
- **Motivation**  
The dog should show joyful motivated work. Willingness to work is in the foreground.
- **Concentration/attention**  
The dog should be focused on the handler during the entire work without showing an extremely abnormal body or head posture.  
The verbal commands should always be accepted directly without hesitation.
- **Harmony of the team**  
The presentation should be harmonious. The dog must be able to follow the handler in a normal sequence of steps for a dog.

### 2. Technical correctness - position

In addition to the expressive behavior and a harmonious performance, attention must be paid to a technically correct execution.

- **Position**  
The dog should be straight in line with the handler with its shoulder at the level of the handler's knee.  
Verbal commands must be performed according to the description of the exercise.

### Principles in the assessment of exercises

When assessing an exercise, a distinction must be made between the primary and the secondary components. The primary part of an exercise is determined in all phases by the name of the respective exercise.

This is to ensure that the primary part of an exercise is reflected stronger in the assessment than mistakes in the secondary parts of an exercise.

**The dog's response to the verbal command**

The dog should perform the exercise joyfully at the handler's verbal command. Any behaviors showing of fear or stress will devalue the exercise.

**Additional verbal commands**

1th additional verbal command minus 1,5 Points

2nd additional verbal command minus 2,5 Points

If a dog does not perform an exercise after the 2nd additional verbal command, the exercise is to be awarded 0 points.

If the dog performs the exercise incorrectly (e.g. standing/lying in the sitting exercise, sitting/standing in the down exercise, etc.), the exercise will be devalued at 50%.

If a dog performs the exercise before the verbal command, the exercise is to be evaluated with minus 2 points.

**Execution of the basic position**

The basic position is the sitting position of the dog on the left side of the handler. Each exercise begins and ends with a basic position. The basic position may only be assumed once before each exercise from the forward movement. In the basic position the dog must sit straight, attentive to the handler, with its shoulder blade at knee height to the left of the handler. In the basic position, the handler is not allowed to stand with his legs spread and both arms must be relaxed against the body.

**Build-up**

From the basic position the development is carried out in the exercises "Sit in motion", "Down with recall", "Stand exercise" and "Send out with down". It must be at least 10, but no more than 15 steps before the verbal command is given to perform the exercise.

**Picking up / calling in of the dog**

In the exercises where the dog is picked up, the handler can approach the dog from the front or from behind. When calling the dog, the dog's name may be used instead of the verbal command for approach. The dog's name in conjunction with the verbal command for approach is considered a double command. The dog must approach joyfully, purposefully and directly, and sit close and straight in front of the handler. At the verbal command for the basic position the dog must move directly to the end basic position. This can be done by the dog walking around the handler at the rear or alternatively at the front. If the handler needs an additional verbal command for the dog to go into the final basic position, the exercise is to be devaluated by minus 1.5 points. If two additional verbal commands are required for this, a deduction of 2.5 points. If, after the second additional verbal command, the dog does not take the basic position, the entire exercise is to be rated as "Insufficient".

**Praise**

The dog may briefly be loosened up and praised after each exercise. During the short praise and loosen up (maximal about 5 seconds), the basic position may be left. After this loosening up, the dog must be taken into the basic position and after a timeframe of about 3 seconds, the next exercise starts.

**Report in**

At the beginning of the obedience exercise, both handlers and their dogs must present themselves to the judge. This is done with the dog on leash. The handlers will report to the judge their name, the name of the dog and the examination they are reporting in for

**Start and ending of an exercise**

The judge gives the instruction for the start of an exercise. All others like turns, stops changes in tempo ect. are performed without instructions of the judge. If the handler forgets an exercise, the judge asks the handler to perform the forgotten exercise. There is no point devaluation for this. Forgotten partial exercises will devalue the exercise.

**Scheme of obedience exercises FCI-BH/VT**

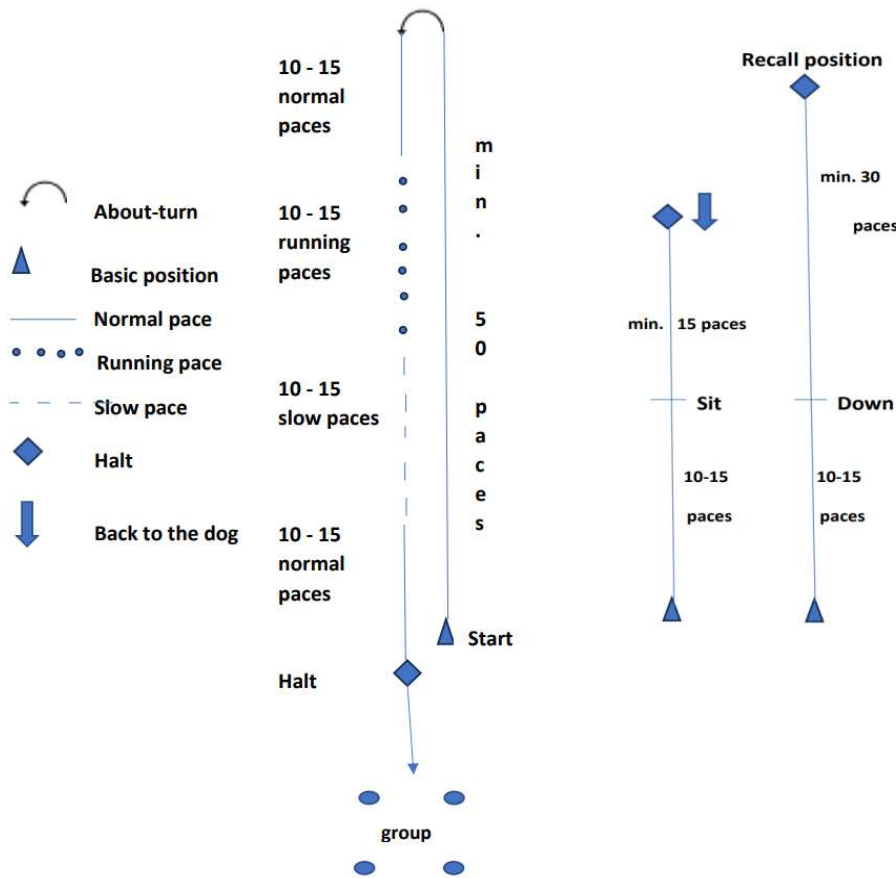

**Start of the exercise:**

Following the judge's instructions, one handler and his dog move to the starting positions for the exercise "Heeling on leash" and the second handler brings his dog to the down position for the exercise "Down under distraction".

**Heeling on Leash**

**30 points**

Execution: At the beginning of the obedience exercise, the handler and the dog must present themselves to the judge. This is done with the dog on leash. The handler will report to the judge his/her name, the name of the dog and the examination they are reporting in for. After the judge's instruction, the handler and his/her dog go to the start position. On further instruction from the judge, the handler starts the exercise. From a straight, calm and attentive basic position, the dog follows the handler attentively, joyfully, straight and quickly on the voice command for "Heel". The shoulder blade of the dog must always remain in position at knee height on the handler's left side and when the handler stops the dog must sit independently, quickly, and straight. At the beginning of the exercise the handler walks straight ahead with his dog for about 50 paces without stopping. After the about turn and another 10 to 15 normal steps the handler shows the running pace and the slow pace (both about 10 - 15 steps each) with the verbal command for "Heel". The transition from the running pace to the slow pace and back to the normal pace must be carried out without intermediate steps and can be done with an extra verbal command for heeling for each speed change. After the last 10-15 normal steps the team makes a halt. Now the handler and dog go into a group of at least 4 moving people. In the group the handler and the dog must go around one person on the left and one person on the right and stop once in the group. On instruction by the judge the handler and the dog return to the starting point and assume the basic position. This is also the starting point for the next exercise.

**Evaluation criteria:**

Running ahead, lateral deviation, staying behind, slow or hesitant sitting, additional verbal commands, body aids, faults in the start position, inattention, lack of enthusiasm/motivation as well as depressed behavior and lack of confidence of the dog lead to a corresponding devaluation.

**Sit exercise****10 points**

From the basic position and on the verbal command for heeling, the team walks in a straight line at a normal gait for about 10-15 steps after which the handler gives the verbal command for sitting. The handler may remain with the dog until it has taken the position and walks in the same normal gait or may walk without waiting for the dog to have taken the sit position. The handler proceeds straight ahead in the same normal gait for about another 15 steps away from the dog, stops, turns to the dog and returns to the dog on the judge's command.

**Evaluation criteria:**

Faults include: Slow sitting, stress behavior, restless and inattentive sitting will be penalized accordingly in addition to other faulty behavior. If the dog stands or lies down, the exercise will be penalized with an additional 50% of the total exercise points. For a dog that does not respond to the 2nd additional verbal command, the exercise is to be marked as "insufficient" (ZERO). In this case the dog may be picked up and the rest of the examination may be continued.

**Down with recall****10 points**

From the start position and on the verbal command for heeling, the team walks in a straight line at a normal gait for about 10 -15 steps after which the handler gives the verbal command for down. The handler may remain with the dog until it has taken the down position or may walk without waiting for the dog to have taken the down position. The handler proceeds straight ahead at the same normal gait for about another 30 paces, stops, turns to the dog and on instruction of the judge calls the dog to him/her. The dog must come motivated in a straight line and sit in front of the handler and is then given the command to take the basic position. The dog may either go around the handler or go directly into the basic position. At the end of the exercise, the dog is put on the leash and led to the exercise "down under distraction" or to the report-out.

**Evaluation criteria:**

Faults include: Slow laying down, restless and/or inattentive behavior while in the down, a slow recall, assistance from the handler such as standing with legs apart, in addition to other faults lead to corresponding devaluation. If the dog sits or stands, the exercise is decreased by an additional 50% of the total exercise. For a dog that does not respond to the 2nd additional verbal command, the exercise is to be marked as "insufficient" (ZERO). In this case the dog may be picked up and the rest of the examination may be continued.

**Down under distraction****10 points**

In the basic position the handler takes the dog off leash, put the leash over the shoulder or put it out of sight and gives, on the instruction of the judge, the verbal command for down. The dog needs to perform a direct down without stress. After the dog has assumed the down position, the handler moves away for about 10 meters, stops, and stands side wards of the dog. During the exercise the dog has remain calmly in the down position without any influence from the handler while the other dog works. After the other team has completed the "down with recall" exercise, the handler goes to his dog at the judge's instruction and stands next to him. When instructed again by the judge, the handler takes the dog into the final basic position with the command for "sit".

**Evaluation criteria:**

Faults include: errors in the basic positions, restless behavior, aids from the handler, standing up from sitting too early or leaving the down position lead to corresponding deductions. If the dog leaves the down position by more than 3 meters before the completion of the other dog's free-heeling exercise, the exercise will be evaluated with 0 points. Otherwise, the exercise can be awarded a maximum of 5 points. If the dog goes to the approaching handler for the pickup, up to 3 points are deducted.

**Examination in traffic****General information**

Only dogs that passed successfully the obedience part allowed to start the traffic examination. The following exercises take place outside the training area in a suitable environment within public areas. The judge, together with the trial director, determines where and how the exercises are to be carried out in



public traffic areas (streets, paths or squares). Public traffic must not be impaired. The performance of this part of the trial requires a considerable amount of time due to its specific nature. The performance requirements must not be compromised by superficial acceptance of any dog. Points are not awarded for the individual exercises of part B. The overall impression of the dog moving in traffic/public determines if the dog passes this part of the trial. The exercises described below are suggestions and may be individually adapted to local conditions by the judge. The judge is entitled to repeat or vary exercises in case there is doubt in the evaluation of the dogs.

**Examination procedure (The following exercises are a minimum requirement and can be extended by the national organizations).**

#### **Encounter with group of persons**

On the instructions of the judge, the handler walks with the leashed dog on a sidewalk by a road. The judge follows the team at a reasonable distance. The dog will follow willingly on the handler's left side on a loose leash. The dog is to behave indifferently towards pedestrians and traffic. On his way the handler and the dog are cut off by a passer-by (order person). The dog must remain neutral and unimpressed. The handler and the dog continue through a group of at least 6 people, in which one person addresses the handler and greets him with a handshake. The dog must sit or lie down next to the handler when instructed to do so by the handler and must remain calm during the short conversation.

#### **Encounter with cyclists:**

The leashed dog is walks with his handler along a path and is first overtaken from behind by a cyclist who gives a bell signal. At a significant distance the cyclist turns and comes towards the handler and the dog. At the same time the cyclist gives another bell signal. The dog must pass so that it is between the handler and the passing cyclist. The leashed dog must behave towards the cyclist in an unbiased manner.

#### **Encounter with cars**

The handler walks his leashed dog past several cars. One of the cars is started. A door is slammed on another car. While the handler and dog continue walking, a car stops next to them. The window is rolled down and the handler is asked for information. At the same time, the dog must sit or lie down on the handler's command. The dog must be calm and unimpressed by cars and all traffic noises.

#### **Encounter with joggers or inline skaters**

The handler walks along a quiet path with his leashed dog. At least two joggers overtake him without slowing down. Once the joggers have moved away, the joggers returns and come towards the handler and dog again and pass them without reducing speed. The dog does not have to heel correctly but must not disturb the overtaking or oncoming persons. It is permissible for the handler to place his dog in the sit or down position during the encounter. Instead of joggers, one or two inline skaters may overtake the handler and dog and come back towards them.

#### **Encounter with other dogs**

When overtaking and approaching another dog with dog handler, the dog must remain neutral. The handler may repeat the verbal command "Heel" or place the dog in the sit or down position during the encounter.

#### **Behavior of the dog leashed and left alone in traffic for a short time, behavior towards animals**

At the instructions of the judge, the handler walks along the sidewalk of a moderately busy street with the dog leashed. After a short distance and on the instruction of the judge, the handler stops and attaches the leash to a fence, wall ring or similar. Then the handler goes out of sight into a shop or house entrance. The dog may stand, sit or lie down. During the handler's absence, a passer-by (person assigned by the judge) with a leashed dog passes the tied up dog at a lateral distance of about five paces. The dog left alone must remain calm during the handler's absence. The dog that is being led past (do not use reactive dogs) must pass without any reactive behavior (strong tugging on the leash, continuous barking). The dog is to be picked up on the judge's instructions. Note: It is up to the judge to decide whether to carry out the individual exercises with each dog at the respective designated places or whether to allow all candidates to complete only a few exercises and then move on to the next test place and proceed in the same way there.



## International Companion Dog Tests FCI-IBgH 1-3

### Distribution and values of the exercises in the individual levels

Exercise	FCI-IBGH-1	FCI-IBGH-2	FCI-IBGH-3
Heeling on leash	30 points	20 points	
Free heeling	30 points	20 points	20 points
Sit out of motion	15 points	15 points	10 points
Down out of motion with recall	15 points	15 points	10 points
Stand out of motion with recall			10 points
Retrieve on the flat		10 points	15 points
Retrieve over the scaling wall (140 cm)			15 points
Send out with down		10 points	10 points
Down under distraction	10 points	10 points	10 points
<b>Total</b>	<b>100 points</b>	<b>100 points</b>	<b>100 points</b>

### Special features in FCI-IBGH 1 – 3

In all examination levels in which the dog is called to the handler and in all retrieve exercises, the dog does not have to sit in front of the handler, it can immediately go into the basic position. Before the dumbbell is released, there must be a pause of 3 seconds before the handler takes the dumbbell from the dog with the verbal command "Out".

### Special features in the FCI-IBGH 3:

The order of exercises 2 to 6 will be decided by the Judge by drawing lots from the following 5 variants noted:

Variant 1 : Exercise 2, 4, 5, 6, 3

Variant 2 : Exercise 4, 3, 6, 2, 5

Variant 3 : Exercise 6, 4, 5, 3, 2

Variant 4 : Exercise 3, 2, 6, 5, 4

Variant 5 : Exercise 5, 6, 3, 2, 4

All participants must do exercises 2 to 6 in the same order.

**The dog can receive the title FCI IBgH special if it passes the FCI IBgH3 twice within a 2-day examination (once on each day).**



## General explanations

### The dog's response to the verbal commands

The dog should perform the exercise joyfully, with confidence and immediately at the handler's verbal command. Any behavior of fear or stress will devalue the exercise.

### Additional commands

If a dog does not perform an exercise after the 2nd additional verbal command, the exercise is to be awarded 0 points.

1st additional verbal command is minus 1,5 points

2nd additional verbal command is minus 2,5 points

If the dog performs the exercise incorrectly (e.g. stands/lies down in the sit exercise, sits/stands in the down exercise, etc.), the exercise is devaluated by 50%.

If a dog enters the exercise without a verbal command, the exercise is to be judged with minus 2 points. For retrieve this can be up to minus 2 points.

### Start of the examination

At the beginning of the exercise, the handler and his dog must present themselves by telling the judge his/her name, the dog's name and the level they will show.

The dog to be shown first must assume the start position when the dog for the long down under distraction has also assumed the start position. Judging always begins when both dogs presented have assumed the basic position for the first exercise to be shown. This is done with the dog leashed in the FCI-IBgH1 and IBgH2 and in the IBgH3 off leash.

### Beginning and end of an exercise

The judge gives the instruction for the start of an exercise. Everything else, such as turns, stops, changes of gait, etc. are carried out without instruction. The given time intervals, approx. 3 seconds, are to be observed, e.g. when changing from the lead to the final basic position, holding and handing over the retrieve, praising the dog and for the beginning of a new exercise. If the handler forgets an exercise, the judge will ask the handler to show the missing exercise. No points will be deducted. Omission of partial exercises will affect the score.

### Execution of the basic position

The basic position is the sitting position of the dog on the left side of the handler. Each exercise begins and ends with a basic position. The basic position may only be assumed once before each exercise from the forward movement. In the basic position the dog must sit straight, attentive to the handler, with its shoulder blade at knee height to the left of the handler. In the basic position, the handler is not allowed to stand with his legs spread and both arms must be relaxed against the body.

### Development

From the basic position the development is carried out in the exercises "Sit in motion", "Down with recall", "Stand exercise" and "Send out with down". It must be at least 10, but no more than 15 steps before the verbal command is given to perform the exercise.

### Picking up / calling in of the dog

In the exercises where the dog is picked up, the handler can approach the dog from the front or from behind. When calling the dog, the dog's name may be used instead of the verbal command for approach. The dog's name in conjunction with the verbal command for approach is considered a double command.

### Praise

Praise is only permitted in the basic position after each exercise. If this is also the new starting position for the next exercise, the time interval of approx. 3 seconds must be observed.

### Exception for FCI-IBgH1

The dog may briefly be loosened up and praised after each exercise. During the short praise and loosen up (maximal about 5 seconds), the basic position may be left. After this loosening up, the dog must be taken into the basic position and after a timeframe of about 3 seconds, the next exercise starts

### Timelines:

In the following situations, time intervals of approx. 3 seconds must be adhered to:

- Praise – Beginning of a new exercise
- Sit in front – transition to the final home position



- Sit in front – taking the dumbbell
- After taking the dumbbell - transfer to the final basic position
- End of an Exercise – Praise
- Basic Position – verbal command- execution of the exercise

**Position error**

In all technical exercises (sit, down, stand), the overall exercise is devalued by 50 % in the case of a position error, apart from further faults.

**Retrieve**

A lunge is permitted when throwing the dumbbell. After pulling back the leg, a pause of approx. 3 seconds must be observed. After consultation with the judge, left-handers are permitted to give the dog the "sit" command in order to be able to throw the dumbbell after taking a step sideways. The handler then approaches the dog again to continue the exercise after a pause of approx. 3 seconds.

If the dog does not release the dumbbell after the third command, the dog is disqualified for disobedience.

**Dumbbell**

Dumbbells belonging to the handler are permitted in the retrieve exercises.

The following provisions must be fulfilled by the dumbbell:

- The bar must be made of wood.
- The distance from the bar to the floor must be at least 4 cm.

**Scaling wall**

The scaling wall consists of two climbing walls connected at the top, 150 cm wide and 191 cm high. At the bottom, these two walls are to be placed so far apart that the vertical height is 140 cm for the exercise in FCI-IBgH 3. The entire surface of the inclined wall must be covered with a non-slip surface. On the upper half of each wall there are 3 climbing rails 1500/24/48 mm. All dogs in a trial must climbjumb the same obstacle. Trial climbing jumps are not permitted during the performance.

**Primary and secondary items in evaluation.****Principles in the evaluation of exercises:**

Principles for the evaluation of exercises: In order to be able to evaluate the performance in a more differentiated way, some exercises are divided into sub-areas, which are then to be considered separately. The evaluation shall also distinguish between the primary part and the secondary part of an exercise. The primary part of an exercise should be weighted higher in order to get to the core of the exercise take into account accordingly.

More details can be found under the exercise descriptions.



### Scheme of obedience FCI-IBgH1

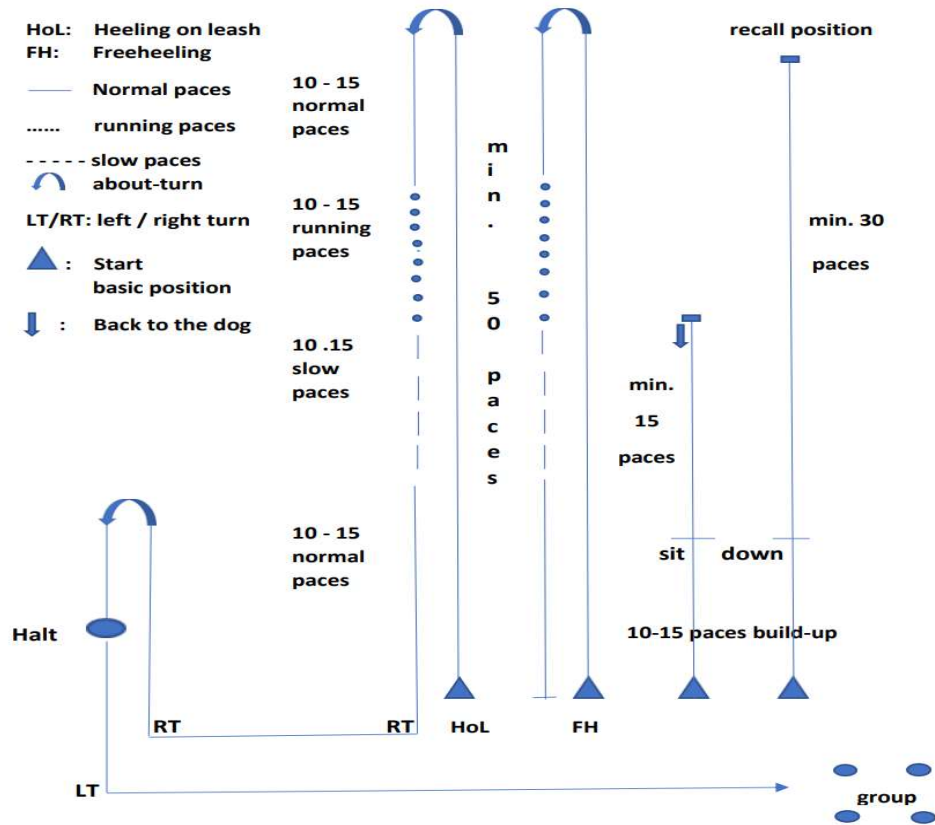

### Scheme of obedience FCI-IBgH2

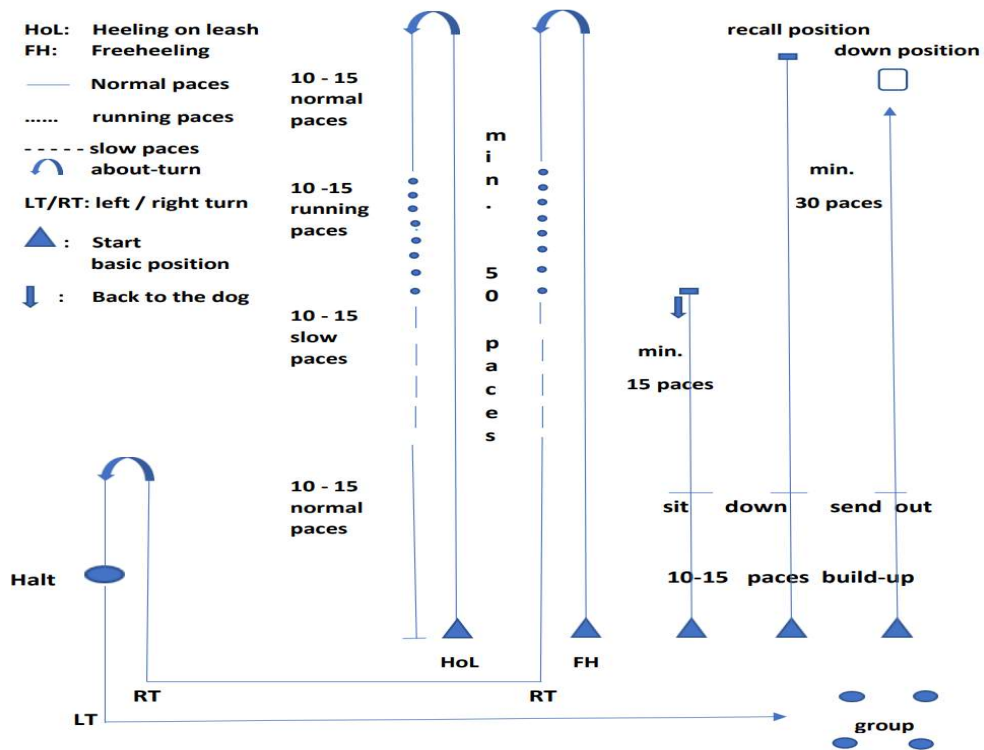

### Scheme of obedience FCI-IBgH3

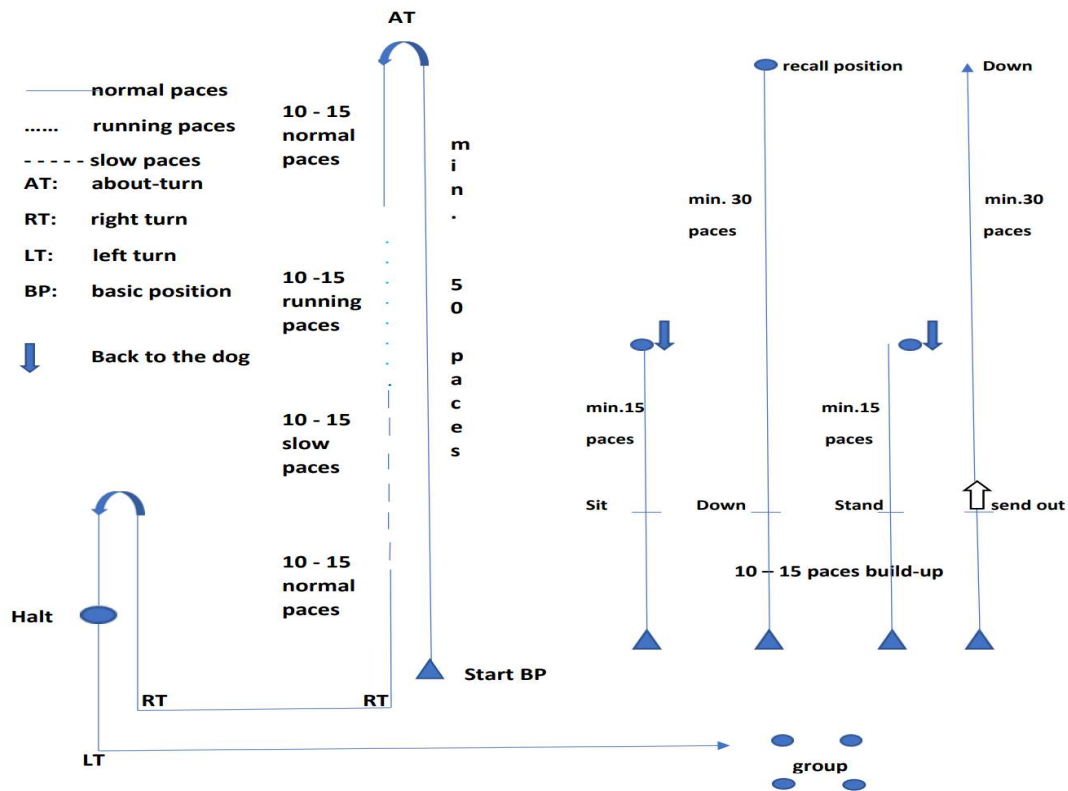

### Exercise descriptions

Before the start of the demonstrations, the judge must check that the prescribed equipment is available and complies with the FCI IGP examination regulations.

#### Heeling on leash FCI-IBgH 1

The dog must follow its dog handler attentively, joyful and with concentration from the basic start position with a single verbal command for "Heel", and should remain on the handler's left side with the shoulder blade at the handlers knee height. The course of the heeling is given according to the scheme FCI-IBgH1. The handler must assume the basic position at the latest when the second handler assumes the basic position for the exercise "Down under distraction". After minimum 50 paces in normal gait, the handler and the dog must show the about-turn to the left. The dog may run around the handler to the right or remain at the handler's knee height, during the about-turn to the left. Hereafter the team must show 10-15 paces in normal gait and go over in 10-15 paces in running and thereafter go over in 10-15 slow paces. After the slow paces the team must go over to normal paces. The running paces and the slow paces must be clearly different from the normal gait. The change of paces is performed without intermediate steps. After the second about-turn, a halt must be shown. The dog must sit down directly without a command. After this, the handler and the heeling dog must go, according to the scheme, through a group of at least 4 moving people. In the group, the handler and the heeling dog must go around a person on the right and a person on the left (e.g. in the form of a figure 8) and stop at least once in the group near a person. The judge is free to require a repetition. At the instruction of the judge, the handler with the heeling dog leaves the group and takes the final basic position, which is also the start of the next exercise. Praising the dog after leaving the group is only permitted in the final basic position.

#### Heeling on leash FCI-IBgH 2

The dog must follow its dog handler attentively, joyful and with concentration from the basic start position with a single verbal command for "Heel", and should remain on the handler's left side with the shoulder blade at the handlers knee height. The course of the heeling is given according to the scheme FCI-IBgH2. The handler must assume the basic position at the latest when the second handler assumes the basic position for the exercise "Down under distraction". After about 50 paces in normal gait, the handler and the dog must show an about-turn to the left. The dog may run around the handler to the right or remain at the handler's



knee height, during the about-turn to the left. Hereafter the team must show 10-15 paces in normal gait and go over in 10-15 paces in running and thereafter go over in 10-15 slow paces. After the slow paces the team must go over to normal paces. The running paces and the slow paces must be clearly different from the normal gait. The change of paces is performed without intermediate steps. After the last 10-15 normal paces, the team makes a halt. The dog must sit down directly without a command. After 3 seconds the dog is taken of leash.

**Evaluation criteria:****Primary items:**

Correct position of the dog, positive expression of the dog (motivated, free, concentrated).

**Secondary items:**

Basic positions.

**Faults:**

Running ahead, lateral deviation, staying behind, slow or hesitant down, additional verbal commands, body aids, mistakes in the basic position, inattention, lack of enthusiasm/motivation as well as depressed and lack of self-confidence of the dog, lead to corresponding devaluation.

**Free heeling FCI-IBgH 1**

The course of the heeling is specified according to the scheme FCI-IBgH1 (one straight line in normal paces, about-turn, normal paces, running paces, slow paces, normal paces, halt) and the execution follows the description of the exercise heeling on the leash. The free heeling is also to be shown on the paths between the exercises.

**Free heeling FCI-IBgH 2 and FCI-IBgH 3**

The dog must follow its dog handler attentively, joyful and with concentration from the basic start position with a single command for "Heel", and should always remain on the handler's left side with the shoulder blade at the handlers knee height. The course of the heeling is given according to the scheme FCI-IBgH2+3. The handler and the dog must show the about-turn to the left. The dog may run around the handler to the right or remain at the handler's knee height, during the about-turn to the left. Hereafter the team must show 10-15 paces in normal gait, go over in 10-15 paces in running and thereafter go over in 10-15 slow paces. After the slow paces, the team must go over to normal paces. The running paces and the slow paces must be clearly different from the normal gait. The change of paces is performed without intermediate steps. After the second about-turn, a halt must be shown. The dog must sit down directly without a command. After this, the handler and the heeling dog must go, according to the scheme, through a group of at least 4 moving people. In the group, the handler and the heeling dog must go in the group around a person on the right and a person on the left (e.g. in the form of a figure 8) and stop at least once in the group near a person. The judge is free to require a repetition. At the instruction of the judge, the handler with the heeling dog leaves the group and takes the final basic position, which is also the start of the next exercise. Praising the dog after leaving the group is only permitted in the final basic position.

The free heeling is also to be shown on the paths between the exercises.

**Evaluation criteria:****Primary items:**

Correct position of the dog, positive expression of the dog (motivated, free, concentrated).

**Secondary items:**

Basic positions.

**Faults:**

Running ahead, lateral deviation, staying behind, slow or hesitant down, additional verbal commands, body aids, mistakes in the basic position, inattention, lack of enthusiasm/motivation as well as depressed, lacks of self-confidence of the dog, just as ramped and abnormal running of the dog lead to corresponding devaluation.

**Sit in motion: FCI-IBgH 1, FCI-IBgH 2 and FCI-IBgH 3**

1<sup>st</sup> part: initial basic position, development/ buildup, execution of the "sit". 50% of the points.

2<sup>nd</sup> part: moving away from the dog and returning to the dog, final basic position. 50% of the points.

On instruction of the judge the handler must start the exercise with a verbal command to heel. After a build-up of about 10 -15 paces in a straight line and in a normal gait, the handler gives the dog, without changing gait or looking back, a verbal command for "sit". Upon the verbal command the dog must sit immediately, in one move, without showing stress or fear behavior and attentive to the handler. The handler moves away another 15 paces and turns towards the dog.



On the judge's instruction, the handler returns, in a normal gait to the dog and goes directly into the basic position.

Hereafter the handler is allowed to briefly praise the dog.

**Special provision for FCI-IBgH1 and FCI-IGP1:**

After the buildup, the handler may stop and give the verbal command for "sit". After the dog has taken the sit position, the handler moves away from the dog to proceed the exercise.

**Evaluation criteria:**

**Primary items are:**

The direct and fast way of execution of the sit, the way the dog reacts to the verbal command.

**Secondary items are:**

The basic positions at the beginning and end of the exercise, the buildup and the attention to the handler.

**Faults:**

Slow sitting, shown stress, fear and unsure reactions on receiving the verbal command, restless sitting or not attentive to the handler will give point deduction in addition to other faults. If the dog stands or lies down, the exercise is additional deducted by 50 % of the total points.

**Down with recall**

1st part: Initial basic position, development, execution place. 50% of the points

2nd part: Approach, sit in front, final basic position. 50% of the points.

On instruction of the judge, the handler must show the "down with recall" exercise starting from a basic position. This basic position can be the final basic position of the "sit" exercise". The build-up of minimum 10 to maximal 15 paces is carried out off leash in the normal pace. On the verbal command for heeling, the team walks in a straight line at a normal gait for about 10 -15 steps after which the handler gives the verbal command for down.

On the verbal command for "down", the dog must immediately down, straight in the correct direction without the handler changing his/her motion or looking back. The handler walks at least 30 paces and turns directly toward the dog. The dog must remain calm and attentive to the handler. On the instruction of the judge, the handler calls the dog with the dog's name or command "Here". The dog has to come immediately, with attention and willingness to the handler and sit close and straight in front of the handler or goes directly in the end basic position. After 3 seconds sitting in front of the handler and on the handlers command, the dog must directly go into the final basic position. Hereafter the handler is allowed to shortly praise the dog.

**Special provision FCI-IBgH 1**

After the development, the handler may stop and give a command for lying down before moving away from the dog. (The timing must be observed).

At the end of the exercise, the dog is put on the leash and led to the exercise "down under distraction" or to the report-out.

**Evaluation criteria:**

**Primary items:**

The execution of the "down", the way the dog accepts the command, the quick execution of the down, the approach to the handler and the front sit.

**Secondary items:**

The basic positions at the beginning and end of the exercise, the build-up and attention during the removal of the handler.

**Faults include:**

Slow laying down, restless and inattentive lying down, not approaching with determination, aids from the handler such as straddling position, in addition to other faults, lead to the corresponding devaluation. If the dog sits or stands, the exercise is penalized with an additional 50% of the total exercise points. For a dog that does not respond to the 2nd additional verbal command, the exercise is to be marked as "insufficient" (ZERO). In this case the dog may be picked up and the rest of the exam may be continued.

**Stand exercise FCI-IBgH-3**

1st part: Initial basic position, development, execution of Stand. 50% of the points.

2nd part: Approach of the handler, final basic position. 50% of points.

After a build-up of 10 to 15 paces in normal gait and on a verbal command of the handler for "stay", the dog must stop immediately and stand straight in the direction of movement, without the handler interrupting or altering his normal gait. The handler walks at least another 15 paces and then turns to face his dog. On the



instruction of the Judge, the handler returns to the dog, stands on the right side and takes the dog with a verbal for "sit" or "heel", into the basic position.

**Evaluation criteria:****Primary items:**

The execution of the command to stand, the way the dog accepts the command.

**Secondary items:**

The basic positions at the beginning and end of the exercise, the build-up and attention during the removal of the handler.

**Faults include:**

No immediate standing, restless and inattentive standing, aids from the handler, in addition to other faults, leads to a corresponding devaluation. If the dog sits or lies down, the exercise is devalued by an additional 50 % of the total points.

**Retrieve on flat**

From a straight start position, the handler throws the dumbbell about 10 meters away. A square mark of 4 by 4 meters is made on the ground, starting at a distance of 8 meters after the position for the start position. The dumbbell must lie within this square. If it lies outside, it is placed in the center of the square by an assistant who moves away behind the handler's position before the command for retrieve may be given. A lunge is permitted during the throw, but a pause of approx. 3 seconds must be observed after the basic position is assumed again. The verbal command to retrieve may only be given when the dumbbell is lying still. At the verbal command for retrieve, the dog must run directly to the dumbbell, pick it up immediately and bring it directly to the handler. The dog must show purposeful, motivated forward and backward movements. The dumbbell must be presented in the sit in front or alternatively in the end position. If the dog is presenting in front-sit, bumping the handler is not allowed. During the retrieve and also during the presentation, the dumbbell must be held calmly until the handler, after a pause of approx. 3 seconds, takes the dumbbell from the dog with the verbal command for "out". The dog must without hesitation allowed the dog handler to take over the dumbbell. After a further pause of approx. 3 seconds and on a verbal command for "heel", the dog is to be taken into the basic position.(if necessary). The dumbbell is to be held in the right hand with the handler's arm extended downwards. The handler is to place the dumbbell in the stand provided for this purpose. While doing this, the dog has to heel as described in free heeling.

**Evaluation criteria:****Primary items:**

The execution of the retrieve, the evenly motivated run to the fetch and back to the handler, the close front sit or alternatively the correct final basic position on the handler with confident and free presentation as well as the willing delivery of the dumbbell.

**Secondary items**

The execution of the basic positions at the beginning and at the end.

**Faults include:**

Unmotivated and undirected action of the dog during the way out to the dumbbell and the way back after picking up the dumbbell, faults in picking up, dropping the dumbbell, playing or nipping, straddling position of the handler, faults in the lead and in the basic positions (e.g. restless behavior) will devalue the exercise as well as any help from the handler.

**Retrieve over the scaling wall**

The handler takes up the basic position with his dog at least 4 meters in front of the scaling wall. From a straight basic position the dog handler throws his own dumbbell over a 140 cm high scaling wall. A lunge is permitted during the throw, but a pause of approx. 3 seconds must be observed after the basic position is assumed again. The dog is to sit freely and quietly next to the handler. When the dumbbell is thrown, the dog and handler are in the basic position. A square mark of 2 by 4 meters is placed on the ground, starting at a distance of 6 meters after the scaling wall. The dumbbell must lie within this square. If it lies outside, it is placed in the center of the square by an assistant. The assistant moves to the rear of the handler's position before the verbal command for retrieve may be given. At the command for "high", the dog is to execute the climb-jump; during the climb-jump out, the command for retrieve is to be given. The dog is to run directly to the dumbbell, pick it up immediately and bring it directly to the handler with a return climb-jump. The dog must perform the entire exercise with motivation and show powerful climb-jumps. The dumbbell can be presented in the front-sit or alternatively in the end basic position. If the dog is presenting in front-sit, bumping the handler is not allowed. During the retrieve and also during the presentation, the dumbbell must be held calmly until after a pause of approx. 3 seconds the handler takes, with the verbal command for release, the dumbbell from the dog. The dog must without hesitation allowed the dog handler to take over



the dumbbell. After a further pause of approx. 3 seconds, the dog is, with a verbal command for "heel" to be taken into the basic position. The dumbbell is to be held in the right hand and with the handler's arm extended downwards. The handler is, with his heeling dog, to place the dumbbell in the stand provided for this purpose.

**Evaluation criteria:****Primary items:**

Powerful and determined climbing jumps, the execution of the retrieve, the evenly motivated running to the dumbbell and back to the handler, the tight front sit or alternatively the correct final basic position on the handler with confident and free presentation, as well as the willing delivery of the wood.

**Secondary items:**

Execution of the basic position at the beginning and at the end.

**Faults include:**

Unmotivated, undetermined action of the dog, mistakes in picking up, dropping the dumbbell, playing or nipping, straddling position of the handler, mistakes in the lead and in the basic positions (e.g. restless behavior), aids from the handler lead to a corresponding devaluation.

In order to receive a partial score, the dog must bring and show at least one climb-jump and the retrieve. A climb-jump must be shown. For a climb-jump not shown, a compulsory score of minus 5 points is given in addition to other faults.

**Send out with down**

1st part: Initial basic position, development, execution running ahead. 50% of the points.

2nd part: Acceptance of the verbal command to "lie down", final basic position. 50% of the points.

If the dog does not allow itself to be sent out by the handler for at least 50% of the required distance, or if it also does not allow itself to be stopped with 3 commands, the exercise is rewarded "insufficient" with 0 points.

At the single verbal command to send the dog ahead and the simultaneous single raising of the arm, the handler sends the dog ahead and stops the dog on instruction of the Judge. After the verbal command, the dog must run away purposefully, in a straight line and at a fast pace for at least 30 paces in the direction indicated. On the command of the judge, the handler gives the verbal command to lie down, whereupon the dog must lie down immediately. The handler may hold up his arm in a directional manner until the dog has lain down. At the instruction of the judge, the handler goes to the dog and stands to the dog's right. After approx. 3 seconds and on a verbal command for "Sit", the dog must sit up quickly and straight in the basic position. At the end of the exercise, the dog is put on the leash only at the level FCI-IGP2 and led to the exercise "down under distraction" or to the report-out.

**Evaluation criteria:****Primary items:**

Direct, straight and fast running ahead and direct execution of the command to lie down.

**Secondary items:**

Errors in the build-up and basic positions

**Faults include:** Not resolutely going ahead, delaying the laying down, restless lying as well as errors in the basic positions lead to further devaluation of the exercise.

**Deductions:**

Dog allows itself to be stopped on the 1st voice command, but does not lie down. One additional verbal command for laying: **-1.5 points**

Dog allows itself to be stopped on 1st sound signal, lies down on 2nd additional verbal command: **-2.5 points**

Dog can be stopped on 1st verbal command, but does not lie down on 2nd additional verbal command: **-3.5 points**

Dog can only be stopped on the 1st additional verbal command. Lies down **-2.5 points**

Dog can only be stopped on the 2nd additional verbal command. Lies down. **-3.5 points**

Dog cannot be stopped on 2nd additional verbal command. **0 points**

Dog has taken up position directly on the 1st verbal command to lie down, but stands up after the Judge has given the instruction to the dog handler to pick up the dog, allows himself to be stopped by a verbal command up to 50% of the distance to the dog handler: Score up to -5 points.

Faults in the development, not resolutely going forward, delaying the laying down, restless lying as well as errors in the basic positions lead to further devaluation of the exercise.

**Down under distraction**

During the presentation of the other dog, the exercise „Down under Distraction“ is to be shown. The dog is, with the verbal command for “laying down” to be put down from the basic position at a place assigned by the Judge. The dog must lie down quietly without the handler’s intervention while the other dog is working. The handler must then take the following position, depending on the trial level, at the command of the Judge. In FCI-IBgH-1 the handler is at least 10 meters away in sight of the dog, positioned sideways to the dog. In FCI-IBgH-2, the dog handler is at least 20 meters away in sight of the dog (but with the handler’s back turned towards the dog). FCI-IBgH-3, the dog handler is at least 30 meters away out of sight.

**Evaluation criteria:****Primary items:**

Safe lying in the same place, calm behavior.

**Secondary items:**

Errors in the basic positions.

**Faults include:**

Errors in the basic positions, restless behavior, aids from the handler, standing up too early, standing or sitting down too early, leaving the place where the dog is put down will lead to appropriate deductions. When leaving the down for more than three meters, the following rules apply to receive a partial score of 50% minus other misconduct:

FCI-IBGH 1: Partial score possible when handler has completed the second exercise.

FCI-IBGH 2: Partial score possible when handler has completed the third exercise.

FCI-IBGH 3: Partial score possible when the dog in the lead has completed the third exercise.

If the dog goes to the dog handler when he/she is approaching for the pick-up, up to 3 points are deducted.



## International Utility Dog Examinations (IGP 1-3)

There are 3 levels of difficulty for the working dog tests. In each level the dog must achieve at least a satisfactory result in 3 phases (**A** tracking work, **B** obedience teamwork, **C** protection ).

### Phase A - Tracking

#### General provisions

	FCI-IGP 1	FCI-IGP 2	FCI-IGP 3
<b>Leash length</b>	5 meters	10 meters	10 meters
<b>Track</b>	Own track	Strange track	Strange track
<b>Length</b>	Min. 300 steps	Min. 400 steps	Min. 600 steps
<b>Legs</b>	3	3	5
<b>Corners</b>	2. Approximately 90°.	2. Approximately 90°.	4. Approximately 90°.
<b>Distance between the corners</b>	Min..50 steps	Min. 50 steps	Min. 50 steps
<b>Articles</b>	3 own articles 3x 7 points	3 strange articles 3x 7 points	3 strange articles 3x 7 points
<b>Articles size</b>	10x2-3x0,5-1cm	10x2-3x0,5-1 cm	10x2-3x0,5-1 cm
<b>Position of the articles</b>	1st on 1st leg, 2nd on 2nd leg, last at the end All on judge's orders	1st on 1st leg, 2nd on 2nd leg, last at the end All on judge's orders	1th on the 1st leg or 2 <sup>nd</sup> leg after at least 100 steps. 2 <sup>nd</sup> on judge orders and the 3rd at the end.
<b>Track aging time minimum</b>	20 minutes	30 minutes	60 minutes
<b>Working time maximum</b>	15 minutes	15 minutes	20 minutes

#### Trackable ground

All natural ground such as meadows, fields and forest ground can be used for tracking. In all examination levels, changing terrain and path crossings are also possible for adaptation to the track terrain.





### Laying the track

Only in FCI-IGP1 the track is laid by the handler. In all other FCI-IGP tracking levels the track must be laid by a strange tracklayer.

In FCI-IGP IFH-2 and FCI-IGP-3 examinations and FCI-IGP 3 competitions, it is advised that a certified tracklayer determines the course of the track depending on the existing terrain and makes a drawing of the track for the judge. This drawing includes terrain features (e.g., trees, wire poles, huts, etc.), the number of paces for each leg and the placement of the articles. The judge/tracking coordinator supervises the laying of the tracks and instructs the tracklayers. The tracks must be laid differently; corners and articles must not be at the same position or at equal distances for each track. The start of the track (scent pad) must be marked by a starting pole or starting flag which is placed directly into the ground to the left of the scent pad. The tracklayer stays briefly at the beginning of the track and after that, he/she goes in natural gait with normal steps in the directed direction. The track and corners are to be laid in a normal, continuous gait. (no open corners; see sketch on page 104).

Help by the tracklayer by unnatural gait, scuffing or stamping is not permitted. Articles are not to be placed within 20 paces before or after the corner and must be placed on the track. The articles must be placed on the track while walking. After laying the last article, the tracklayer must continue at least 10 paces in a forward direction.

In all levels where the track is not laid by the handler, the handler and dog are not allowed to watch the track being laid.

The order of the participants in the tracking work is determined by drawing lots after the tracks have been laid and in the presence of the judge or a person appointed by him/her.

### Special feature

Only in the FCI-IFH 3 may the handler ask the judge to briefly interrupt the tracking work if he feels that he/she or the dog needs a short break due to physical condition and/or weather conditions (e.g. high temperature). The break will count towards the time available for the tracking work. The handler may clean the dog's head, eyes and nose and give the dog some water to drink during the break or if there is an article indication. For this purpose the handler may carry some water, a wet cloth or a wet sponge. The water, cloth or sponge must be shown to the judge before the start of the track. No other motivational aids are allowed.

### Articles

Articles are not to be placed within 20 paces before or after the corner and must be placed on the track. The article must be laid on the track while walking. Articles may not differ significantly in color from the terrain. The articles must be laid between the footsteps or alternatively, if the terrain condition requires, in the footsteps.

Before laying the track, the articles must be shown by the handler (FCI-GP-1) or by the tracklayer (FCI-IGP2, FCI-IGP3) to the judge or tracking coordinator. Only articles that the handler /tracklayer has carried for a minimum of 30 minutes in his/her pocket may be used.

Within a track the articles must be made of different materials (e.g., leather, textiles, wood). In FCI-IGP Championships the articles must be numbered. These numbers must correspond to the track number and must be placed one after the other.

If one (1) article is not indicated and cannot be found by the tracklayer, there will be no deduction. If there are more articles not indicated and cannot be found, the team will be offered a new track. If the handler refuses this new track, all not indicated articles will be evaluated as not found. This rule does not apply to FCI-IGP1, where the handler is the tracklayer. In these cases when an article is not indicated by the dog, no points will be awarded for these articles.

### Indicating of the articles

Indicating can be done sitting, lying down, and standing; alternating in a track is allowed. The indicating of the article can also be done by the dog picking up the article. After picking up the article the dog may stand still, sit, or retrieve the article to the handler. Picking up the article and laying down is faulty, as well as going forward with the article. If the dog retrieves the article, the handler must drop/put down the leash and must remain at the end of the leash from the moment of retrieving until the moment of collecting the article. The dog must retrieve the article in a direct way and can sit or stay in front of the handler while presenting the article, the handler collects the article (with the command for an out) and restarts the dog to track from this place while standing in front/ just behind or next to his/her dog.

The articles must be indicated without any help from the handler in a direct and convincing way without stress or avoidance signals. Once the dog has indicated the article in the final position (standing, sitting laying down), the handler drops or puts down the tracking leash, goes directly to the dog, picks up or collects the article and shows it to the judge. This can be done either on the left or on the right side of the dog. This

all may be done by the handler without the approval of the judge. The indicating must be done directly and in the direction of the track. Slightly crooked (+/-30 degrees) laying down, sitting, or standing to the article is not faulty. While remaining in his position, it is not faulty if the dog is looking back in the direction of the handler. To be an excellent indication, the article must lie directly in front of or between the front paws. It is not necessary for the dog to fix (stare) at the article.

The dog must remain calm and without any stress or avoidance signals in its position until restarted on the track. Articles that are found with strong help of the handler will be consider as missed. After the article is shown to the judge, a re-start is made with a verbal command to track. The restart after indicating an article must be done close to the dog (upright next to or just behind the dog) without approval of the judge.

**Sketch for evaluating the articles**

**A= Direction of the track.**

**B= 2nd part of the body of the dog**

**Distance between the paws and the articles 8 and 9 maximum about 20 cm.**

The sketch below, serves as a rough orientation. The following factors must be taken into account in the assessment:

- Wind conditions
- Size of the dog
- Position of indicating (sitting, lying, standing)

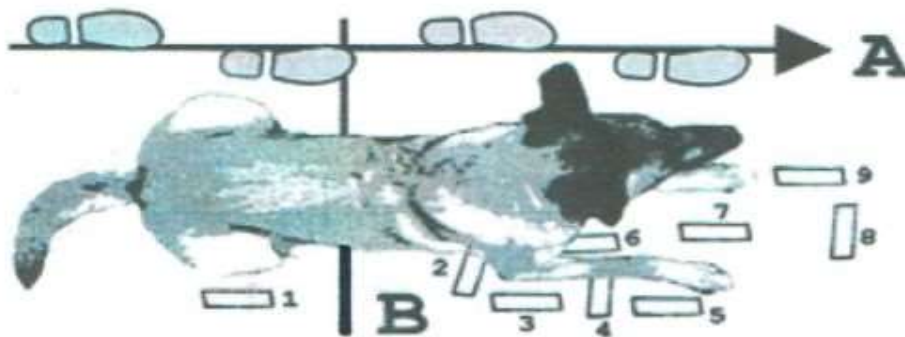

**Allocation of points for the articles**

Insufficient=Ins., Satisfactory=Sat., Good=G., Very good=VG., Excellent=Ex.

	Max.	No. 1 Ins.	No. 2 Sat.	No.3 G	No.4 G	No.5 VG	No.6 VG	No.7 EX.	No.8 Ex/VG	No.9 Ex/VG
FCI-IGP-1	7 pts.	4	5	5,5	5,5	6,5	6,5	7	6,5	6,5
FCI-IGP-2	7 pts.	4	5	5,5	5,5	6,5	6,5	7	6,5	6,5
FCI-IGP-3	7 pts.	4	5	5,5	5,5	6,5	6,5	7	6,5	6,5

**Tracking leash**

The length of the tracking leash is 5 meters for FCI-IGP1 and 10 meters for FCI-IGP 2 and FCI-IGP 3. A check of the length of the leash, the collar, and the tracking harness or the Böttger harness (if used) by the judge or an authorized person must take place before the start of the tracking work (at the latest when reporting in). Flexible leashes are not permitted. The tracking leash may be passed over the back, at the side of the dog or between the front and / or hind legs. It may be attached either directly to the loose-fitting collar or to the attachment ring of the harness (chest or Böttger harness without additional straps). When using a harness, ensure that the back strap does not extend beyond the dog's last rib. The tracking leash may



occasionally sag during the track, but the required distance between handler and dog must not be greatly reduced. Occasional ground contact of the leash is not faulty. The handler must follow the dog while holding the end of the leash. It is irrelevant how he/she holds the leash - with one hand, with two hands, whether he/she changes the leash to the other hand, at what height he/she holds the leash, etc., if this does not interfere with the dog's work. There must not be handler help given by how the leash is held or by changing the tension of the leash.

For small dogs, the prescribed normal loose-fitting collar may be replaced by another suitable collar.

**Free Tracking:** During off-leash tracking work, a distance of at least the described 5 (IGP1) or 10 meters (for all other levels) must be maintained between handler and dog.

### Report in / Report out

When the team has been called to begin the track, the handler reports to the judge with the dog in the basic position and prepared for tracking. The handler states whether his/her dog will pick-up, retrieve or indicate the articles. During the report the dog may be on a short leash. After reporting in, the dog may be led on a short leash up to approx. 2 meters to the start of the track and then removed. Any compulsion is to be avoided before and during the entire track. At the instruction of the judge the dog is led calmly to the start of the track (a verbal command to follow is permitted) and set off on the search at the scent pad with a verbal command. The dog may sit or stand for a short time or lie down in front of the start of the track (approx. 2 meter away) so that the track leash can be brought into the position desired by the handler (leash between front and/or behind legs). The dog must be started at the starting flag with the handler next to or just behind the dog.

After finishing the track and while reporting out, the articles found must be shown to the judge. Playing or feeding after indicating the last article, before reporting out and receiving the score, is not permitted. The reporting out must take place in the basic position. After this, the short leash can be put on the dog.

### Working the Track

The dog must be given a verbal command to track at the starting flag. The handler has a maximum of 3 commands to start his/her dog. If the dog does not start the track after 3 commands, the tracking must be terminated, and the result is 0 points. The second and third attempts lead to a deduction in the evaluation of the first leg. For each extra command there is a mandatory deduction of -1,5 points. The dog must start the track with a deep nose and then work the entire track with a deep nose, with self-confident, high tracking intensity, consistent and even speed. It is important to see for the whole track that the dog is the one that leads and is making the decisions. The search speed is not a faulty criterion if the dog is tracking in a convincing and intensive manner.

The start (also when restarting after the finding of the articles) must be done with the handler standing upright next to or just behind the dog and with a verbal command to track. The handler must remain stationary until the entire line is rolled out. The way the handler lengthens (releases) the leash is not important if it does not affect the dog's work. During the track, the handler is allowed to use gloves.

A certain amount of slack in the leash is permitted. The time for preparing the dog and the start of the track is not time-dependent, but the judge must pay attention to the behavior of the dog at the beginning of the first leg as to how intensely the dog commits to the track and takes the scent. If the dog is caught in the tracking leash, the handler may ask the judge for permission to untangle the dog. After permission by the judge, the handler stops the dog with a verbal command and goes from the end of the leash to the dog. After the dog is untangled, the handler goes back to the end of the leash and restarts the dog with a verbal command to track; there is no point deduction. After the handler has shown the judge the last article found by the dog, the judge gives a sign to finish the work. From that moment the judging ends. Then there may be brief praise and relaxation of the dog is allowed (without playing). After that, the handler is obliged to report out to the judge on the completion of work with the dog in the basic position. While the dog is tracking, the judge must choose the distance to the dog in such a way that he does not hinder the dog in his search (about 10 meters away).

Ending the track in all levels: After the indication of the last article, the dog does not need to be brought in the basic position before going to the judge for reporting out. The handler with his/her dog on leash does not need to show "heeling on leash" but is free to choose the way of going directly to the judge for reporting out. Reporting out must be done with the dog on leash and in the basic position.

### Corners

The dog must work out corners confidently and convincingly. Circling at the corner is faulty and leads to point deduction. A head check without leaving the track is permitted without deduction. After the corner, the dog must continue with the required high intensity, deep nose and at the same speed.



In the corner area the dog handler must maintain the prescribed distance to the dog. However, the handler is not allowed to leave the track until the dog has worked out the corner confidently.

### **Praise/Encouragement**

Only in FCI-IGP 1, occasional short (one word) praise/encouragement on the track is permissible, but only when the handler follows the dog in a straight line and not in the range of corners, not when the dog corrects a mistake or shows uncertainty and not before indicating an article. In addition, short praise at the article is permitted in all levels. This can be done either before or after picking up and showing the article to the judge, but not both. The handler is also not allowed to praise the dog while picking up the tracking leash for the restart.

### **Termination/Disqualifications**

If the dog leaves the track and is held back by the handler, the judge must instruct the handler to follow the dog. If the judge's instruction is not followed, the track must be terminated. If the end of the track is not reached within the maximum time specified for the individual levels, the track will be terminated by the judge. The performance shown until termination is evaluated. If the dog breaks off the track (remains in the same place without working, raises its head, comes back to the handler etc.), the track may be terminated even if the dog is still on the track and the time available has not yet expired. If during the track wild game appears and the dog follows its hunting instinct, the handler may attempt to prevent the dog from following the wild game by giving the dog the verbal command to down. At the command of the judge, the dog handler calls his dog to him and starts him again with the voice command for "search". If the dog does not continue the track, it is terminated.

### **Termination**

In the case of a termination, all points awarded up to then are awarded along with the points of the phases that have been completed so far. The points reached up to the point of termination are entered in the scorebook. If the dog is terminated in phase C, phase C is to be evaluated with 0 points, the points reached in sections A and B are retained.

### **Reasons for Termination in all levels**

Dog is started on the track 3 x unsuccessfully at the scent pad or after the article indication.

Dog leaves track by more than one leash length or handler disregards the judge's instruction to follow the dog. Dog is not at the end of the track in the given time.

Handler is not obeying the judge's instruction to follow the dog.

The dog can no longer be used after it has been distracted by wild animals.

### **Disqualification**

All points awarded up to the time of disqualification (DQ), including those from other phases, will be deleted. No points or scores will be entered on the scorebook. After disqualification, the team may not participate in any other phase. The reason for the disqualification must be entered in the scorebook by the judge.

<b>Reasons for disqualification</b>	<b>Entry in the certificate of achievement</b>
The dog does release the article picked up.  During the free tracking, the dog leaves the track by more than 10 meters and does not return after 3 voice commands.	Disqualification due to disobedience
The dog is not neutral during the impartiality check	Disqualification due to lack of impartiality



Unsportsmanlike conduct of the handler (e.g. transport of motivational objects and/or food).  Handler acts contrary to the FCI-IGP, animal welfare or morality with suspicion of attempted fraud through the use of prohibited training aids.	Disqualification for unsportsmanlike conduct
---	--

**Evaluation of the tracking performance:**

A distinction must be made between primary and secondary elements. Primary elements are to be weighted more strongly in order to evaluate the essentials of the tracking work accordingly.

**Primary elements:**

Intensity, self-confidence, concentration, direct persuasive referring.

**Secondary elements:**

Distance between the handler and dog, speed of going down when indicating.

**Assessment:**

- The assessment of each leg depends on the length, the terrain, and the weather conditions, and is based on the level in which the dog is tracking. The judge and all accompanying persons may not be in the tracking area where the team has the right to track (10 meters radius around the tracking team and 10 meters distance to the next track).
- After indicating the article, the handler may approach the dog without the permission of the judge. The judge can, together with the handler, approach the dog to see the position of the indicated article. Approaching by the judge must be done without disturbing the dog. After checking the indicated article and before the restart of the dog, the judge must move away again so as not to disturb the restart.
- During the whole tracking performance, the dog may not be disturbed by either the tracklayer or the judge. For his/her evaluation, the judge must not only look at the dog and the handler, but must also consider the terrain, the weather, possible distractions, and the track age time. The judge must base his/her assessment on the totality of all influencing variables. The assessment is to be carried out considering the following criteria:

**Tracking:**

- Motivated behavior of the dog with a deep nose, constant intensity, and consistent speed before and after the corners, as well as before and after indicating the articles.
- Training level of the dog, (hectic approach, stressed behavior, avoidance behavior are unwanted).
- Cooperation between handler and dog
- Difficulties in working out the tracks:
- Tracking conditions such as: vegetation, soil, terrain changes, manure.
- Wind conditions
- Wild game
- Weather conditions: wind, heat, cold, rain, snow.
- Weather changes

The judge must assess the desire, the confidence, working temperament, the sureness or uncertainty, stress, or avoidance behavior of the dog in his/her work. If the dog is committed immediately to tracking at the start and follows the scent path with a deep nose and makes an excellent first leg, the judge will not mention in his evaluation that the dog should have taken more time to identify or take the scent.

**Deductions for all examination levels:**

- If the handler gives the verbal command to start before the flag a deduction of – 1 points. In this case the dog was started without a command at the starting flag. If the dog start sniffing before the flag without a verbal command of the handler, this is not faulty
- A dog that starts searching without a command before the starting flag will not be deducted as if it is stopped at the starting flag and started with a verbal command to start tracking.
- If the dog stops tracking by falsely indicating an article and the handler does not go to the dog but gives an extra command at the end of the tracking leash “Such”, “Track”, “Find”, etc. there will be a deduction of -2 points at all FCI-IFH levels.
- If the dog stops tracking by falsely indicating an article and the handler does go to the dog and gives the tracking command next to the dog „Such”, “Track:”, “Find”, etc. there will be a deduction of - 4 points at all FCI-IFH levels.
- The handler is not allowed to help the dog at the start or restart by indicating the direction of the track. Deduction for this help is -2 points
- Wandering, urinating, or defecating, circles at the corners, continuous encouragement, leash help or verbal help in the track or at the articles are faulty and deducted accordingly.
- Urinating/defecating = - 8 points

**Tracking forms****FCI IGP1 and 2**

The following examples of track shapes can also be used as mirror images

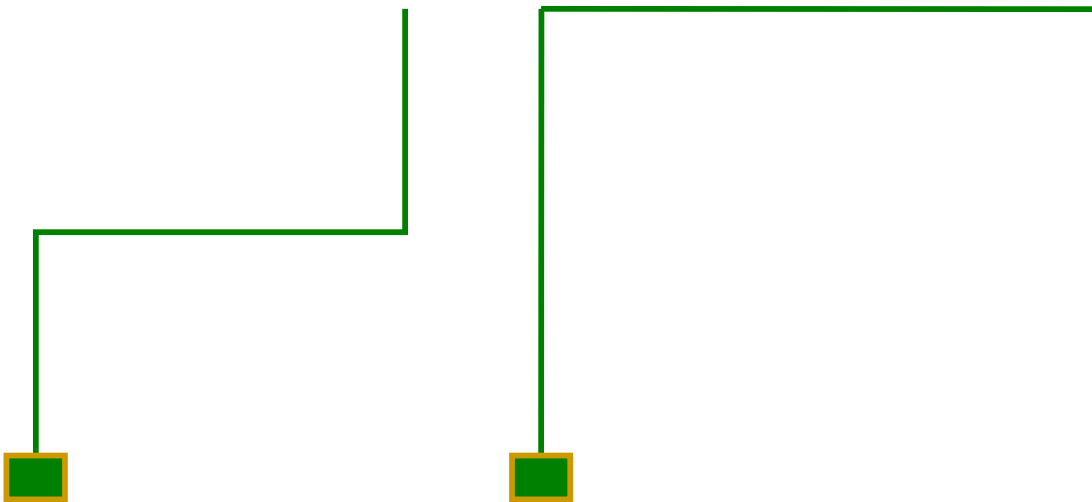

**Tracking Forms IGP-3:**

The following examples of track shapes can also be laid in mirror image.

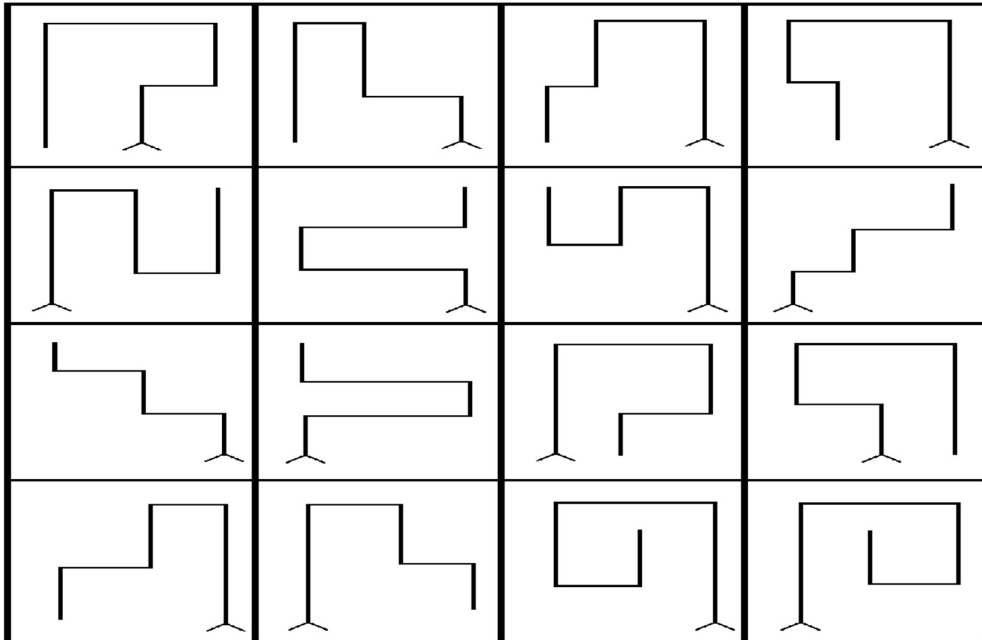

**Laying the corners:**

**Corner to the right**

**Corner to the left**

Winkel rechts

Winkel links



**Laying the articles**

If the vegetation is too high, the articles can also be placed in the footprints.



**Phase B - Obedience**

<b>Exercise</b>	<b>FCI-IGP-1</b>	<b>FCI-IGP-2</b>	<b>FCI-IGP-3</b>
Free heeling	15 points	15 points	15 points
Sit in motion	10 points	10 points	10 points
Down with recall	10 points Out of motion in normal gait	10 points Out of motion in normal gait	10 points Out of motion in running pace
Stand exercise		10 points Out of motion in normal gait with picking up the dog	10 points Out of motion in running pace with recall
Retrieve on flat	15 points	10 points	10 points
Retrieve / jump over the 1 meter hurdle	15 points Two jumps without retrieving	15 points Two jumps with retrieving	15 points Two jumps with retrieving
Retrieve/ climbjump over the scaling wall	15 points One (1) climbjump without retrieving <b>Height 160 cm</b>	10 points One (1) climbjump without retrieving <b>Height 160 cm</b>	10 points Climbjumps with retrieving <b>Height 160 cm</b>
Send out with down	10 points	10 points	10 points
Down under distraction	10 points	10 points	10 points
<b>Total</b>	<b>100 points</b>	<b>100 points</b>	<b>100 points</b>

**General explanations****Verbal command (vc)**

When retrieving, the dog's name may be used instead of the verbal command for the recall. The dog's name in combination with any verbal command is considered a double command.

The dog's response to the verbal command: The dog should perform the exercise joyfully and confidently at the handler's verbal command. Behaviors of fear or stress will lead to point deductions for the exercise.

**Additional command**

1st additional verbal command is minus 1,5 points

2nd additional verbal command is minus 2,5 points





If a dog does not perform an exercise after the 2nd additional verbal command, the exercise is to be awarded with 0 points.

If a dog enters the exercise without a verbal command, the partial exercise is to be judged "unsatisfactory".

If the dog performs the exercise incorrectly (e.g. stands/lies down in the sit exercise, sits/stands in the down exercise, etc.), the exercise is devalued by 50%.

If a dog enters the exercise without a verbal command, the exercise is to be judged with minus 2 points. For retrieve this can be up to minus 2 points.

### Reporting in

At the beginning of the obedience exercise, the handler and his/her dog present themselves to the judge in the basic position and tell the judge his/her name, the name of the dog and the level and phase they are showing for. This is done with the dog on leash at the FCI-IGP1 level and off lead for the FCI-IGP-2 and FCI-IGP3.

### Start and end of an exercise

The dog to be presented must assume the initial basic position when the dog to be placed under distraction for the long down has also assumed the initial basic position. Judging always begins when both dogs presented have assumed the start position for their respective exercise.

The judge gives the instruction for the start of an exercise. Everything else, such as turns, stops, changes of gait, etc. are carried out without instruction. The given time intervals of approx. 3 seconds are to be observed when changing from the front to the final basic position, holding and handing over the dumbbell before the out command, praising the dog and for the beginning of a new exercise. If the handler forgets an exercise, the judge will ask the handler to show the missing exercise. No points will be deducted. Omission of partial exercises will affect the score.

### Execution Basic of the position

The initial basic position is the dog's sitting position on the handler's left side. Each exercise begins and ends with a basic position. The initial start position may only be assumed once before each exercise from the forward movement. In the basic position the dog must sit straight, attentive to the handler, with its shoulder blade at knee height to the left of the handler. In the basic position the handler may not stand with the legs spread and both arms must be relaxed against the body. This can be done by the dog walking around behind the handler or alternatively going directly to the left side of the handler. If the handler requires an additional command for the basic position, the partial exercise is to be deducted by minus 1,5 points. If he/she requires a second additional command, the partial exercise is to be deducted by minus 2,5 points. If the dog does not assume the basic position after the second additional verbal command, the entire exercise is to be evaluated "insufficient".

### Development / build up

From the basic position the development / build up is carried out in the exercises "Sit in motion", "Down with recall", "Stand out of motion" and "Send out with down". It must be at least 10, but not more than 15 steps before the command is given to perform the exercise.

### Pick-up / call in the dog

During the exercises in which the dog is picked up, the handler can approach the right side of the dog from the front or around from behind. When calling the dog, the dog's name may be used instead of the verbal command for the recall. The dog's name in conjunction with the verbal command for the recall is considered a double command. The dog must come quickly, joyfully, purposefully and directly, and sit close and straight in front of the handler. At the verbal command for the basic position the dog must go directly into the final basic position.

### Praise

Praise is only permitted in the basic position after each exercise. If this is also the new starting position for the next exercise, the time interval of approx. 3 seconds must be observed.

**Exception for FCI-IGP 1:** The dog may briefly be loosened up and praised after each exercise. During this time (maximum about 5 seconds), the basic position may be left. Afterwards, the dog must be taken into the basic position and after about 3 seconds, the next exercise starts.

**Time intervals in each stage**

In the following situations, time intervals of approx. 3 seconds must be adhered to:

- Praise – start of a new exercise
- Sit in front – transfer to the basic position
- Sit in front – taking the dumbbell
- Taking the dumbbell – transfer to the basic position
- End of an exercise – praise
- Basic position – verbal command

**Position error**

In all technical exercises (sit, down, stand), apart from further misconduct, the overall exercise is devalued by 50 % in case of a position error.

**Retrieve**

A lunge is allowed when throwing the timber. After pulling the leg in, a break of about 3 seconds must be observed. For left-handers, it is allowed, after consultation with the judge, to give the dog the handler "sit" in order to be able to throw the bring wood after a step sideways.

After that, the handler steps back up to the dog to continue the exercise after a break of about 3 seconds. If the dog does not hand over the dumbbell after the third verbal command it will be disqualified for disobedience.

During the retrieving exercises, only the dumbbells provided by the organizer of the exam are allowed. All participants must work with the same dumbbells. The following provisions apply to the nature of the dumbbells:

The bar must be made of wood.

The weights given must be correct.

The distance from the bar to the ground must be at least 4 cm.

	<b>IGP-1</b>	<b>IGP-2</b>	<b>IGP-3</b>
On the flat	650 gram	1000 gram	2000 gram
Hurdle	Without retrieving	650 gram	650 gram
Scaling wall	Without retrieving	Without retrieving	650 gram

**Hurdle**

The hurdle has the following dimensions: For all levels: Height 100cm, width 150cm.

Practice jumps are not permitted during the examination.

**Scaling wall**

The scaling wall consists of two climbing walls connected at the top, 150 cm wide and 191 cm high. At the bottom, these two walls are to be placed so far apart that the vertical height is 160 cm. The entire surface of the inclined wall must be covered with a non-slip surface. On the upper half of each wall there are 3 climbing rails 1500/24/48 mm. All dogs in a trial must climb-jump the same obstacle. Trial climbing jumps are not permitted during the performance.

Before the start of the trial, the judge must check that the prescribed equipment is available and that it complies with the FCI-IGP trial regulations. During the judging of each exercise, the dog's behavior must be carefully observed, starting with the basic position and ending with the end of the exercise.

**Primary and secondary elements in the assessment**

Principles for the evaluation of exercises:

In order to be able to evaluate the performance in a more differentiated way, some exercises are divided into sub-areas, which are then to be considered separately. The evaluation shall also distinguish between the primary part and the secondary part of an exercise. The primary part of an exercise should be weighted higher in order to get to the core of the exercise take into account accordingly.

More details can be found under the exercise descriptions.

**Scheme of obedience exercises FCI-IGP**

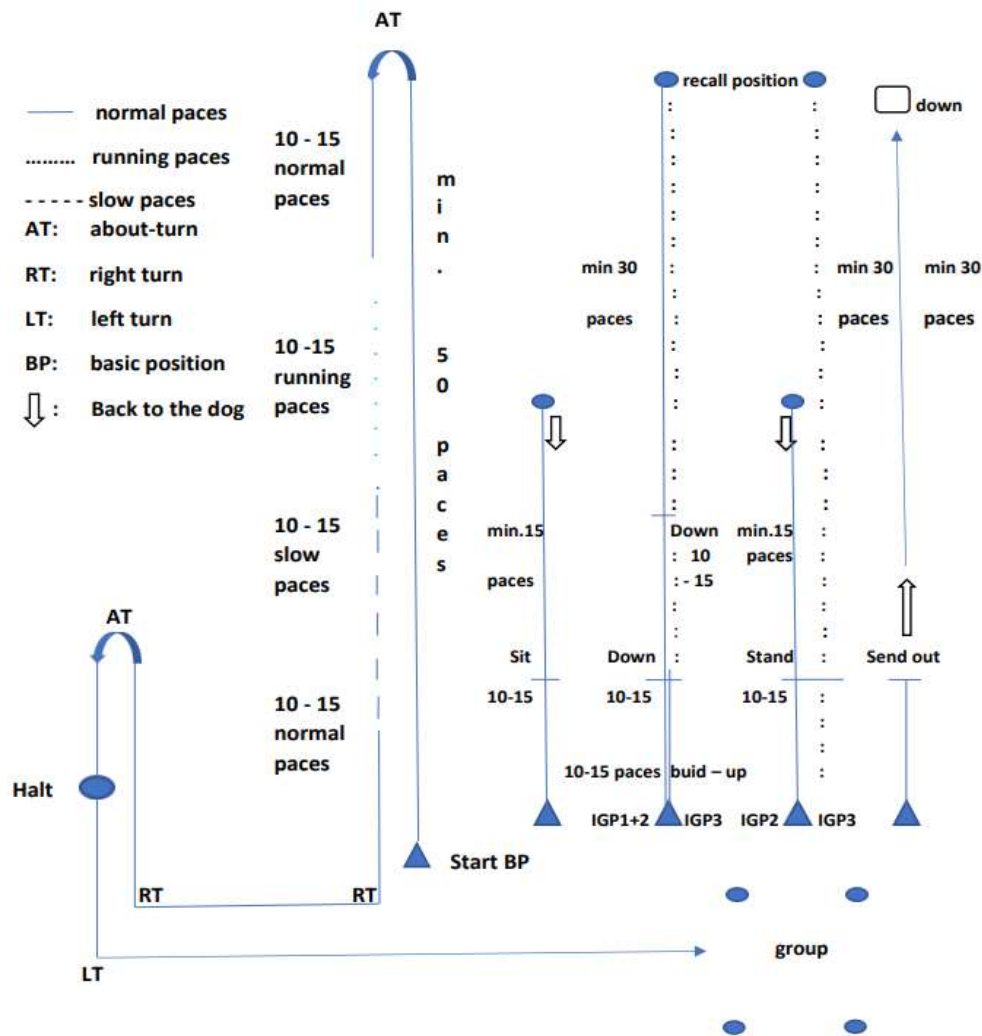

**Exercise descriptions:**

**Free heeling**

The dog must follow the handler attentively, joyfully and with concentration from the basic start position with a single command for "Heel" and should always remain on the handler's left side with the shoulder blade at the handler's knee. The heeling is done according to the heeling pattern below. On the first straight line, two shots (6mm caliber) are fired at a time interval of 5 seconds from a distance of at least 15 paces to check the shotgun sureness. The handler must assume the basic position at least by the time when the second handler assumes the basic position for the exercise "Down under distraction". The dog handler and the dog must show an about turn to the left. During the about turn the dog may go behind the handler to the right or remain at the handler's left knee. The running pace and the slow pace must be clearly different from the normal gait. The change of pace is performed without intermediate steps. After the second about turn, a halt is to be shown. The dog must sit directly without a command. The handler and the heeling dog must go in the group around a person on the right and a person on the left (e.g. in the form of a figure 8) and stop at



least once in the group near a person. The judge is free to require a repetition. At the instruction of the judge, the handler with the dog leaves the group and takes up the final basic position. Praising the dog after leaving the group is only permitted in the final basic position. The free heeling is also to be shown when moving between the exercises. On the first straight line, two shots (caliber 6 mm) are fired at a time interval of 5 seconds apart with the first one after at least 15 paces, to check the gunshot sureness of the dog.

**Evaluation criteria:****Primary items:**

Correct position of the dog, positive expression of the dog (motivated, free, attentive, concentrated to the handler).

**Secondary items:**

Basic positions.

**Faults include:**

Forging, lateral deviation, lagging, slow or hesitant sits, additional verbal commands, handler help, mistakes in the basic position, inattention, lack of enthusiasm/motivation as well the dog's behavior being depressed, showing lack of confidence, nervousness, hecticness and abnormal activity lead to corresponding point losses. The dog must be indifferent to the gunshots. If the dog is gun-shy he will be disqualified and all the points already acquired will be removed. If the response of the dog is not clear, the judge can check the gunshot sureness of the dog separately with additional shots.

**Sit in motion**

1st part: Initial basic position, build-up, execution of the "sit". 50% of the points

2nd part: Moving away from the dog and return by the handler, final basic position. 50% of the points

On instruction of the judge the handler must begin the "sit" exercise.

After a build-up of a minimum of 10 to a maximum of 15 paces in normal heeling, the dog must sit immediately and straight upon the verbal command without the handler changing his gait or looking back. The dog must accept the command without stress or fear behavior and remain calm and attentive to the handler.

The handler moves away 15 paces in the same normal gait and turns directly toward his/her dog. On the judge's instruction, the handler returns in a normal gait to his/her dog and goes directly into the basic position. Afterwards the handler is allowed to briefly praise his/her dog.

**Special provision for FCI-IGP 1:** After the build-up, the handler may stop and give a verbal command for "sit" before moving away from the dog

**Evaluation criteria:**

In this exercise the **primary items are** the direct and fast execution of the "sit", the way the dog reacts to the command and the dog's attention to the dog handler.

**Secondary items are** the basic positions at the start and end.

**Faults include:**

Slow sitting, showing stress, fear and unsure reactions on receiving the verbal command or restless and inattentive sitting receive point deductions in addition to other errors. If the dog stands or lies down, the exercise is additionally reduced by 50% of the total points.

**Down out of motion with recall**

**1st part:** Initial basic position, build up, execution of "down" command, 50% of the points.

**2nd part:** Leaving the dog, recall, final basic position, 50% of the points.

On instruction of the judge, the handler must begin the "down with recall" exercise starting from a basic position. This basic position can be the final basic position of the "sit exercise."

The build-up of a minimum of 10 to a maximum of 15 paces is carried out at a normal pace. On the verbal command for down, the dog must immediately down, straight in the correct direction without the handler changing his/her motion or looking back. The handler walks at least 30 paces and turns directly toward the dog. The dog must remain calm and attentive to the handler. On the instruction of the judge, the handler calls the dog. The dog must come immediately with attention and willingness to the handler and sit close in front of him/her. After 3 seconds the dog handler commands the dog to go to the basic position. Afterwards the handler is allowed to briefly praise the dog.

**Special provision for FCI-IGP1**

After the build-up, the dog handler may stop and give the verbal command for the down before he/she walks away from the dog.

**Special provision for FCI-IGP3**

After the first 10-15 paces in normal gait, the team proceed with another 10-15 paces in running gait before the verbal command for down is given. After the verbal command the handler runs at least another 30 paces and turns directly toward the dog.

**Evaluation criteria:**

**Primary items:** The direct execution of the “down” and the way the dog takes and carry out the command.

**Secondary items are:** the basic positions at the start and end of the exercise.

**Faults include:**

Slow downing, moving while in the down position, showing stress, fear reactions on receiving the command, and restless or inattentive behavior of the dog to the handler lead to corresponding deductions in addition to other errors. If the dog is sitting or standing, the exercise is mandatorily evaluated with – 50% of the total points.

For a dog that does not come on the second extra command, the exercise is to be evaluated “Insufficient” with 0 Points. In this case, the dog may be picked up and continue to the next exercise.

**Stand out of motion FCI-IGP 2**

1st part: Beginning basic position, build-up, execution of stand command, 50% of the points

2nd part: Leaving the dog, return of the handler, final basic position, 50% of the points.

After a build-up of 10 to 15 normal paces and upon the verbal command, the dog must immediately stand straight in the direction of the handler without the handler changing his/her gait or looking back. The dog must remain calm and with attention to the handler while the handler moves away in normal gait about 15 paces and then turns directly to face the dog. On the judge's instruction, the handler returns to the dog, stands on the right side of the dog and commands the dog with a verbal command into the basic position.

**Stand out of motion FCI-IGP-3**

**1st part:** Beginning basic position, build-up, execution of stand command, 50% of the points.

**2nd part:** Leaving the dog, recall of the dog, front position, final basic position. 50% of the points.

After a build-up of 10 to 15 running paces the dog must immediately upon the verbal command stand straight in the direction of the handler without the handler changing his/her gait or looking back. The handler runs at least 30 paces and turns directly to face his/her dog. The dog must remain calm and attentive to the handler until the verbal command to recall to the handler. At the instruction of the judge, the handler recalls the dog with a verbal command “here” or the “dog's name”. The dog must be fast, joyful, purposeful, come directly, and sit close and straight in front of the handler. The dog must go directly to the final basic position upon the verbal command to heel.

**Evaluation criteria:**

**Primary items are;** stopping and standing immediately upon the verbal command, calm behavior without any signs of stress or lack of self-confidence, and attention to the handler. The dog must also show fast and purposeful execution of the recall and a straight sit in front of the handler.

**Secondary items are:** the execution of the initial and final basic positions.

**Faults include:** Restless or inattentive standing, and in FCI-IGP 3, a lack of a fast and purposeful coming on recall and handler help such as a splayed leg stance, lead to corresponding point deductions along with other mistakes.

If the dog sits or downs, the exercise will be evaluated “insufficient” with a mandatory deduction of 50% of the whole exercise. For a dog that does not come on the second extra command, the exercise is to be evaluated “insufficient” with 0 points. In this case, the dog may be picked up and continue to the next exercise.

**Retrieve on the flat for all levels: (FCI-IGP 1 dumbbell weight 650 grams)**

A 4-meter by 4-meter square must be marked on the ground starting 8 meters from the basic position. With the dog sitting in a straight basic position the handler throws the dumbbell within this square.

If the dumbbell lands outside the square, it is placed in the middle of the square by an assistant, who then moves behind the handler's position before the command to retrieve may be given.

If the handler's foot moves while the handler throws the dumbbell no points are lost if it does not affect the dog. If the leg is moved during the throw, a 3 second pause must be shown after returning to basic position.



The verbal command “retrieve”, “bring” may only be given when the dumbbell has stopped moving or after the assistant is behind the handler.

On the verbal command for retrieving or bringing, the dog must run directly to the dumbbell, pick it up immediately, turn directly and return directly to the handler and present the dumbbell directly in the sit in front position. The aim is to show motivated and determined running towards the dumbbell and motivated returns. During the presentation of the dumbbell and also during the retrieving portion, the dumbbell must be held firmly and calmly until the handler commands the dog to release the dumbbell after about a 3 second pause in front. The dog needs to sit directly in front of the handler in a way the handler can easily take the dumbbell from the dog. Touching or bumping the handler is faulty. The dog must present the dumbbell to the handler. After outting the dumbbell and an approx. 3 second pause, the dog is commanded into the final basic position. After outting the dumbbell, the dumbbell is held in the handler's right hand with the arm straight down at handler's side. After another 3 second pause, the handler gives the verbal command for the dog to go into the final basic position. This may be accomplished by the dog either going around the handler or directly from the front to the left side of the handler into the basic position. The handler must then place the dumbbell back on the stand. During this part, the dog must heel with the handler as described for “heeling”. For left-handed people, after permission from the judge to give the dog a “sit” command the handler may take one step to the right, throw the dumbbell, and then step back to the dog to continue the exercise.

**Evaluation criteria:**

**Primary items** in this exercise are: execution of the retrieve, motivated running to the dumbbell and then back to the dog handler with the same speed going out and returning, sitting close in front of the handler and presenting the dumbbell, and the way the dog receives and responds to the out command.

**Secondary items** are the executions of the start and final basic positions.

**Faults include:**

If the dog shows slow behavior, any form of stress, is unmotivated or not purposeful on the way out and/or return, has a faulty pick-up, drops the dumbbell, plays with or mouths the dumbbell, the handler has a splayed leg stance, there are mistakes in the presentation, errors in the sit in front and/or in the basic positions (for example, restless behavior) as well as any dog handler help, there will be point deductions.

**Basic position in front of the hurdle and scaling wall**

The distance of the basic position of the handler in front of the hurdle and scaling wall must be marked at about 4 meters. This is the minimum distance for the basic position for these exercises. The handler is allowed to take his/her basic position behind this line.

**FCI-IGP-1: Two jumps without retrieve over a hurdle**

The handler takes the basic position on or behind the mark in front of the hurdle.

On instruction of the judge the handler starts the exercise. After the command to sit and stay, the handler goes to the other side of the hurdle and stands about 5 meters from the hurdle in the basic position. On the judge's instructions, the handler calls his/her dog with the commands for “jump” and the recall. The dog must show a powerful free jump over the hurdle to its handler and sit straight and close in front of the handler. After a verbal command, the dog must go quickly into the basic position. Hereafter the exercise must be repeated in the same way from the opposite direction.

**Evaluation criteria:**

**Primary items are:** the powerful free jumps with confidence over the hurdle and sit in front of the handler.

**Secondary items are:** mistakes in the start basic position and mistakes in finishing to the final basic position.

**Extra evaluation:**

If the dog touches the jump, up to 1 point is deducted. If the dog steps on the hurdle, up to 2 points are deducted per jump.

Knocking over the hurdle, minus 5 points and the hurdle is replace for the second jump. **Faults include:** faults in the basic position, hesitant and powerless jump, faults in the handler's lead as well as faults in finishing and handler's aids lead to devaluation.

**Retrieve over a hurdle: FCI-IGP 2 and FCI-IGP 3, dumbbell provided by the organization.**

A rectangle 2 meters wide and 4 meters long must be marked on the ground starting 6 meters beyond the hurdle. On instruction of the judge the exercise starts. From a straight basic position the handler throws the dumbbell within this rectangle. If the dumbbell does not land in the rectangle, an assistant (field steward), on instruction of the judge, will hold the dumbbell vertically upwards so the dog can see it and place it in the



middle of the rectangle. The assistant then moves away from the dog's work area (imaginary line behind the hurdle) to behind the handler.

The dog should sit freely and quietly next to its handler. On the verbal command for jumping, the dog must perform a free jump. During the jump the verbal command for retrieving must be given. The dog must go quickly and directly to the dumbbell, pick it up immediately and return with a free jump over the hurdle and return directly to the handler. The dog presents the dumbbell by sitting in a straight front position to its handler. The dog must sit close in front of the handler so that the handler can easily take the dumbbell from the dog. Bumping the handler, even slightly, is faulty. The dog must carry out the entire exercise without any sign of stress and in a motivated way, showing powerful free jumps without touching the hurdle.

During the presentation in front of the handler and during the retrieving process, the dumbbell must be held firmly and calmly. The dog must, for the period of 3 seconds, present the dumbbell sitting close in front to the handler until the dog handler gives the command to release the dumbbell. After outting the dumbbell and an approx. 3 second pause, the dog is to be given a verbal command to take the final basic position either by going around the handler or directly from the front to the left side of the handler. The dumbbell is to be held in the handler's right hand with the arm straight down at handler's side.

The dog handler must then place the dumbbell back on the stand. The dog accompanies the handler in correct free heeling position to the dumbbell stand.

**Evaluation criteria:**

**Primary items** in this exercise are powerful free jumps and correct execution of the retrieve.

**Secondary items** are the execution of the initial and final basic positions.

**Guidelines for evaluation:**

A partial evaluation of the exercise is only possible if at least one of the jumps outward jump – return jump and the part "retrieving" have been completed. If one jump is not shown, the exercise is to be devaluated with 5 points.

**Faults include:**

If the dog shows a slow, stressed, unmotivated, not purposeful jump out and/or back, a faulty pick-up, drops the dumbbell, plays with or mouths the dumbbell, the handler has splayed leg stance, or there are mistakes in the presentation, front and in the basic positions (for example, restless behavior) as well as any handler help, there will be point deductions.

- If the dog touches the jump, up to 1 point is deducted per jump.
- If the dog steps on the jump, up to 2 points are deducted per jump.
- A partial score is possible only if at least one jump and the "retrieve" portion are completed from the three parts (going- out jump - return jump - retrieve) of the exercise.
- If the dog does not jump one direction, either out or back and the dumbbell is retrieved, 5 points are taken (there may be additional mistakes in the performance of the exercise).
- If the dog jumps perfectly out and back but does not retrieve the dumbbell, 0 points.
- If the dog knocks over the hurdle during the jump, there is a deduction of 4 points. If the dog manages to return with the dumbbell over a hurdle that has been thrown over, it earns 1 point. If the return jump cannot be shown due to a knocked over hurdle, the exercise receives 0 points.

**Climb-jump over the scaling wall: For the FCI-IGP1 and FCI-IGP 2, 160 cm high.**

The handler takes the start position in front of the scaling wall. On instruction of the judge and after the command to sit and stay, the handler moves to the other side and stands at a distance of at least 4 m from the scaling wall. On the judge's command he/she calls his/her dog with the verbal command for a climb and come. The dog must come to the handler with a powerful climb and sit straight in front. After approx. 3 seconds the dog is taken into the basic position with a verbal command.

**Evaluation criteria:**

**Primary items** are a powerful climb over the scaling wall and straight sit in front of the handler.

**Secondary items** are mistakes in the initial and final basic position

**Faults include:** faults in the basic position, hesitant and powerless climbing, faults in the handler's lead, as well as faults in finishing and handler help lead to point deductions.

**Retrieve over the scaling wall: FCI-IGP 3, 160 cm high.**

A rectangle 2 meters wide and 4 meters long must be marked on the ground beginning 6 meters from the scaling wall. On instruction of the judge the handler starts the exercise. From a straight basic position the handler throws the dumbbell within this rectangle. If the dumbbell does not land in the rectangle, an assistant (field steward), on instruction of the judge, lays out the dumbbell in the middle of the rectangle and moves away from the dog's work area (imaginary line behind the scaling wall).

The dog should sit freely and quietly next to its handler. After a pause of 3 seconds the handler gives the dog a verbal command to climb-jump and while climbing a verbal command to retrieve. The dog must carry out the entire exercise in a motivated way without stress and show powerful smooth climbing jumps.

After retrieving and the return climb-jump. The dog needs to sit directly in front of the handler in a way the handler can easily take the dumbbell from the dog.

During the retrieve and presentation of the dumbbell to the handler, the dumbbell must be held firmly and calmly for a period of 3 seconds until the dog handler gives the command to release the dumbbell. After another 3 second pause, the handler gives the command for the dog to go into the final basic position. The dog may go around behind the handler or directly from the front to the left side of the handler into the basic position.

The handler then places the dumbbell back on the stand. The dog accompanies the handler in correct free heeling position to the dumbbell stand. At the dumbbell stand the dog is allowed to stand or sit while the handler is taking or placing the dumbbell.

**Evaluation criteria:**

**Primary are** the powerful climb-jumps with confidence and correct retrieving of the dumbbell and the sit in front of the handler.

**Secondary are** mistakes in the initial basic position, mistakes in front position, and mistakes in finishing to the final basic position. Handler help leads to further deductions.

**Faults include:** Unmotivated and unfocused behavior of the dog, mistakes in picking up the dumbbell, dropping the dumbbell, the dog plays with or mouths the dumbbell, the handler stands with legs straddled, mistakes in the sit in front and in the basic positions (e.g. restless behavior), and handler help leads to a deduction in the valuation accordingly. To receive a partial score, the dog must retrieve and show at least one climb. A powerful climb must be shown.

**Guidelines for evaluation:**

A partial evaluation of the exercise is only possible if at least one of the climb-jumps (outward climb-jump – return climb-jump - retrieve) and the part "retrieving" have been completed. If one of the climb-jumps is not shown, the exercise is to be devaluated with 5 points.

**Send out with down**

1<sup>st</sup> part: Basic position, build-up, execution of the send out portion, 50% of the points.

2<sup>nd</sup> part: After instruction from the judge, downing, final basic position, 50% of the points.

From a basic position and on the instruction of the judge, the handler starts the exercise. After a verbal command for heeling, the team starts in a normal gait and in a straight line for about 10 -15 paces. After this 10 – 15 paces the handler gives a verbal command for going out. On the single command for going out while raising the arm, the handler stands still and sends his/her dog out. Then the dog must take a run in a straight path in the shown direction for a minimum of 20 meters. At the instruction of the judge, the handler gives the command for the dog to down, which must be executed immediately. The handler is allowed to hold the arm up in the direction of the exercise until the dog has downed.

If the dog does not go down on the first command, the handler must independently give a second command within three seconds, this is the same for the third command.

At the direction of the judge, the handler goes to his dog and stands right next to him. At the instruction of the judge, the handler gives the command for the dog to sit. The dog must sit quickly, straight and clam in the basic position.

**Evaluation criteria**

**Primary items are:** The way out (direct, straight and fast running ahead) and the direct reaction and execution of the verbal command to go down.

**Secondary items are** mistakes in the build-up, restless while down and mistakes in the pickup and final basic position.

**Faults include:**





Handler help leads to further deductions.

If the dog does not go the minimum distance or cannot be stopped with 3 commands, the exercise receives 0 points

Dog stops on first command but does not down, downs immediately on second command	-1.5 points.
Dog stops on first command but does not down, downs immediately on third command	-2.5 points.
Dog stops on first command but does not down on third command.	-3.5 points.
Dog does not stop on first command, stops and downs immediately on second command	-2.5 points.
Dog doesn't stop on 1st or 2nd command, stops and down immediately on 3rd command	-3.5 points.
Dog cannot be stopped with 3 commands.	0 point.
Dog downs directly on the first command, but after the judge's instructions to go pick-up the dog, the dog breaks, if the dog can be stopped by a maximum of 50% of the distance to the dog handler.	up to -5 points.

Additional mistakes are also deducted.

If the dog returns to the handler for more than 50% of the distance, the exercise is valued with 0 points.

**Faults** in the build-up, slow or unsure going forward, delayed stopping, slow down, restless down as well as mistakes in the pick-up, and basic position lead to additional deductions.

#### **Down under distraction:**

During the performance of the obedience exercises of the other dog, the down exercise is shown under distraction. The dog is placed on a position assigned by the judge from the basic position with the command to down. The handler then must leave the dog and take the position on the instructions of the judge according to the examination level:

**In FCI-IGP1**, the handler is at least 10 meters away in sight of the dog, positioned sideways to the dog.

**In FCI-IGP 2**, the handler is at least 20 meters away in sight of the dog but with the handler's back turned towards the dog.

**In FCI-IGP 3** the handler is at least 30 meters away out of sight.

The dog must lie quietly and calmly without influence by the handler while the other dog is working. In the set up for the down and after the pick-up, the dog must heel in the described way.

#### **Evaluation criteria:**

**Primary** are quiet and calm behavior without moving (crawling, etc.) and no help from the handler.

Premature standing/sitting up or crawling is incorrect.

**Secondary** are mistakes in the basic positions.

#### **Faults include:**

When leaving the down position by more than three (3) meters, the following rules apply to allow a partial deduction of -50% plus other mistakes. If the dog leaves the down position but stays or sits on the place there will be a deduction of -50%.

Partial points are possible if the dog doing the motion exercises has completed the third exercise.

FCI-IGP-1: Partial points are possible if the other dog has completed the third exercise.

FCI-IGP-2: Partial points are possible if the other dog has completed the fourth exercise.

FCI-IGP-3: Partial points are possible if the other dog has completed the fifth exercise.

If the dog goes to the handler when approached for the pick-up, up to 3 points are deducted. If the dog leaves the down position but remains in the range of three meters (FCI-IGP1 two meters) when sitting or standing, there is a deduction of up to -50%.

## Phase C - Protection - (FCI-IGP-1-3)

### General provisions:

### Field markings:

The following field markings must be clearly visible to the handler, the judge and the helper:

- Position of the dog handler for the call out from guarding in the blind.
- Position for the helper to start the escape and the distance (20 paces) by which the dog must be engaged. (See sketch on page 54)
- Arc marking where to position the dog during the setup for escape. (See sketch on page 54)
- Marking for the dog handler for the exercise "Attack on the dog out of motion". (FCI-IGP2+3)

### Blinds

In a suitable location 6 blinds (3 blinds on each side) are staggered on each side of the field (see sketch). All 6 blinds must be set up for all examination levels (FCI-IGP 1-3).

### Basic requirements

Assessing the instinctive behavior, self-confidence, ability to cope with stress, grip performance and obedience is done over the entire protection phase. The dog must be self-confident and dominate to the helper during the entire protection routine. In all protection exercises, the dog is allowed only to grip the provided protection sleeve. Biting other unprotected body parts of the helper leads to immediate disqualification (DQ). In all phases of the exercise the dog must remain unimpressed and show a full, energetic and, above all, consistent grip. In the stick threat test the dog is threatened by the helper with a threat of a blow without being touched or hit. The threat must be made energetically by the helper.

### Evaluation criteria

The following important evaluation criteria are particularly noteworthy:

- Reaction of the dog to the attacks
- Self-confidence, calm and firm grip
- Guarding phase

Self-confident and dominant behavior towards the helpers

- Obedient

The dog must be under the control of the handler during the entire protection service.

### Further evaluation criteria:

Deduction of one category	<ul style="list-style-type: none"> <li>• slightly inattentive guarding and/or slight bothering in the guarding phase</li> </ul>
Deduction of two categories	<ul style="list-style-type: none"> <li>• Very inattentive guarding and/or substantial bothering in the guarding phase</li> </ul>
Deduction of three categories	<ul style="list-style-type: none"> <li>• the dog does not guard the helper, but remains with the helper</li> </ul>
Insufficient	<ul style="list-style-type: none"> <li>• The dog leaves the helper to go to the dog handler during approach</li> </ul>
Termination	<ul style="list-style-type: none"> <li>• the dog does not withstand the pressure from the helper and comes off the sleeve and backs up</li> <li>• the dog leaves the helper before the judge's instruction for the dog handler to approach or the dog handler gives a command for the dog to stay with the helper</li> </ul>

**Outing / Additional verbal commands – Validation and Devaluating:**

If the dog does not let go after the first allowed sound signal, the handler receives the instruction from the referee for up to 2 more sound signals to be lowered.

Slow to out	1 Extra command with immediate out	1 Extra command with slow out	2 Extra commands, immediate out upon second command	2 Extra commands, with slow out upon second command	No out after second extra command
0.5 – 3.0	3.0	3.5 – 6.0	6.0	6.5 – 9.0	Disqualification

If the dog leaves the position between the helper and the handler during the side transport, the transport is stopped and the handler has 2 combined sound signals "Here-Foot" to bring the dog back into the position between himself and the helper. The transport will then continue.

Assessment:

- Exercise back transport FCI-IGP2

1st Additional verbal command -1.5 points "satisfactory"

2nd Additional verbal command -2.5 points "insufficient"

- Exercises "Attack from the back transport" and "Attack on the dog out of motion"

1st Additional verbal command -3.5 points "satisfactory"

2nd Additional verbal command -5.0 points "insufficient"

If the dog does not obey after two additional verbal commands, a disqualification will take place.

If the dog bites the helper's sleeve during the side transport, the handler has one additional verbal command "out"/"here/heel" to bring the dog under control. If the dog obeys this command, the exercise is to be deducted into "insufficient". If the dog is not brought under control, the dog is disqualified for disobedience.

Exercise back transport FCI-IGP2: The entire exercise is rated "insufficient" and a deduction of -2 points. The protection service may be continued. If it is not possible to bring the dog under control, a disqualification for disobedience will take place.

Exercises "Attack from the back transport" and "Attack out of motion" in FCI-IGP3: The entire exercise is rated "insufficient". The protection service may be continued. If it is not possible to bring the dog under control, a disqualification for disobedience will take place.

If the dog leaves the helper before the judge has given the instruction to the handler to approach, the protection service will be terminated.

If the dog leaves the helper after the judge has given the instruction to the handler to approach, the exercise will be rated "insufficient".

Primary and secondary elements of the exercises:

For weighting in the evaluation, a distinction is made between primary and secondary elements of the individual exercises, whereby significant errors in the secondary part can lead to the entire exercise being evaluated as insufficient or a disqualification being pronounced. More detailed descriptions follow with the individual exercises.

**Examination levels FCI-IGP-1 to IGP-3 (exercises and point allocation)**

Exercises	FCI-IGP-1	FCI-IGP-2	FCI-IGP-3
Search for the helper	5	5	10
Hold and Bark	15	15	15
Prevention of attempted escape	20	15	10
Defense against an attack from the guarding phase	30	20	15
Back Transport	-	5	5
Attack on the dog out of the back transport	-	-	15
Attack on the dog out of motion	30	20	15
Defense against an attack from the guarding phase	-	20	15
<b>Total score</b>	<b>100</b>	<b>100</b>	<b>100</b>

**Report in :**

The dog handler reports in to the referee in the FCI-IGP1 level with a leashed dog in the basic position in front of the judge.

In the FCI-IGP2 and FCI-IGP3 levels, the reporting takes place in the basic position with orientation to the judge at the starting point for the exercise by raising the arm. At the signal of the judge, the protection service then begins.

**Exercise descriptions:****Search for the helper:**

The start must take place in the basic position facing downfield to the judge. After acknowledging the judge, a new basic position is taken in the direction of the first blind.

FCI-IGP-1 2 Blinds	FCI-IGP-2 4 Blinds	FCI-IGP- 3 6 Blinds
The dog heels on leash to the starting position on the center line even with blind 5. The handler assumes a basic position there and removes the leash. The handler raises an arm showing his/her willingness to start the exercise. After the judge's signal the dog is sent to blind 5 and then with a verbal command to blind 6.	The dog heels off leash to the starting position on the center line even with blind 3. The handler assumes a basic position there. The handler raises an arm showing his/her willingness to start the exercise. After the judge's signal the dog is sent to start the search exercise.	The dog heels off leash to the starting position on the center line even with blind 1. The handler assumes a basic position there. The handler raises an arm showing his/her willingness to start the exercise. After the judge's signal the dog is sent to start the search exercise.

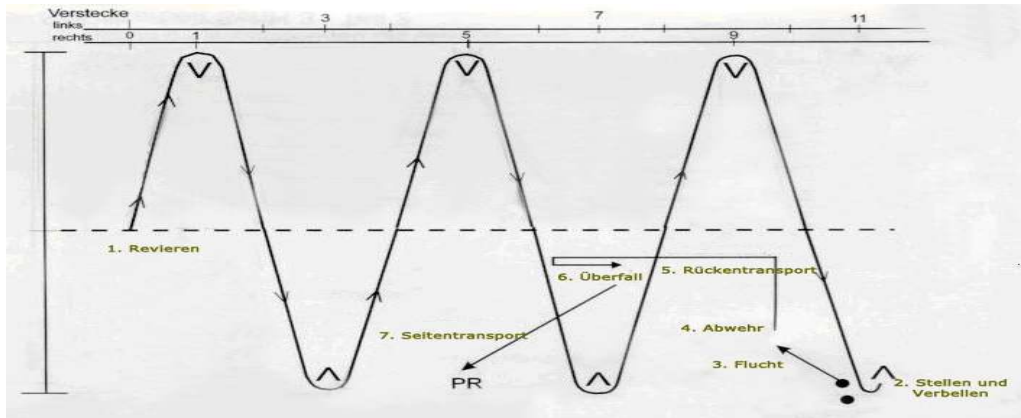

With a verbal command and a hand signal with the right or left arm for direction, the dog is sent to search the blinds. The dog must run fast and directly at the blinds and then go around them closely and attentively. After going around the blind, the handler calls the dog's name and gives a verbal command "here". On this command, the dog must come in the most direct way and then the handler gives a verbal command "reviere"/"search" and at the same time points to the next blind to be searched. The dog's name and a verbal command for "here / search" are to be given in conjunction. The handler moves with a normal pace on the imaginary center line, which he/she must not leave. When the dog has reached the helper's blind, no further commands or hand signals are permitted, and the handler must stop as soon as the dog enters blind 6 and remain standing until he /she receives an instruction from the judge to approach the blind for calling out or picking up.

**Evaluation criteria:**

Primary elements: Determined, concentrated and attentive search for the helper, obedience of the dog.

**Secondary elements:**

Direct approach of the dog to the handler. Tight circling of blinds.

**Faults include:** If the dog is not calm in the basic position at the beginning of the exercise, if the dog is barking or vocal during the blind search, if the dog receives additional commands or hand signals, if the handler leaves the imaginary center line during search, the handler does not move at a normal pace, the dog circles the blind(s) wide, the dog is acting independently and not on the handler's commands, if blinds are not circled or not attentively circled, or the dog is difficult to control, these faults are deducted accordingly. The dog must approach the blinds and the handler directly and purposefully.

If the handler has his/ her dog come into the basic position during the blind search (the dog stops the search and comes to basic position), the exercise is given 0 (zero) points. The routine may be continued if the dog can be sent again. If the dog comes back to the basic position a second time, protection must be terminated. If the dog does not find the helper on the first command, the handler has two additional commands to try to get the dog into blind 6. If the dog does not find the helper on the 3rd command then the protection phase is terminated.

**Hold and Bark: (10 points for hold and 5 points for barking)**

The dog must confront the helper confidently, actively, attentively, and dominant with persistent barking. The duration for barking is approx. 20 seconds before the judge signals the handler to approach. The exercise ends as follows:

FCI-IGP-1	FCI-IGP-2	FCI-IGP-3
<p>The judge instructs the handler when to go to the marked position 5 paces away from the helper. On the judge's instructions, the handler calls his/her dog into the basic position or, alternatively, goes to his/her dog, gives the command "sit", then puts the leash on and heels to the marked position and takes a basic position. Alternatively, the dog may be kept off leash when heeling to the marked position.</p>	<p>The judge instructs the handler when to go to the marked position 5 paces away from the helper. On the judge's instructions, the handler calls the dog into the basic position with the command "here/heel".</p>	<p>The judge instructs the handler when to go to the marked position 5 paces away from the helper. On the judge's instructions, the handler calls the dog into the basic position with the command "here/heel".</p>

**Evaluation criteria:**

**Primary are:** Confident holding and persistent strong barking at the helper.

**Secondary are:** Direct and straight coming into the final basic position.

**Faults include:** Bothering the helper, weakness or limitations in dominance, and lack of persistent barking and confidence while holding the helper until the command for “here/heel” is given, are evaluated accordingly. During the exercise, the dog must not be distracted by the judge or by the handler.

**Further evaluation points:**

Weak, inconsistent, not dominant, non-energetic unfocused barking Dog does not bark, but actively guards the helper	Satisfactory to Insufficient  Insufficient
Bothering the helper by pushing, bumping, etc. The dog bites the sleeve and only releases after approach and a command	Rated accordingly and as low as Insufficient  Insufficient – 14 Points
If the dog leaves the helper before the handler leaves the center line after the judge's instructions.  If the dog does not go back into the blind or leaves the helper again	The dog can be sent in again one time. If the dog remains with the helper, phase C can be continued. Insufficient -14 points.  Termination
If the dog leaves the helper during the handler's approach, or if the dog comes out of the blind before the command	Rated as Insufficient  Rated as Insufficient
If the dog is biting the sleeve in the blind and does not release on its own, the handler is instructed to go to the callout position. The handler is allowed to call the dog with a command to “out” and a “here/heel” command, which must be said as one word.	If the dog comes out to basic position- Insufficient -14  If the dog does not release or come to basic with one command - Disqualification

**Prevention of an attempted escape of the helper:**

Commands for the escape and out.

On the judge's instructions, the handler asks the helper to step out of the blind. The helper goes at a normal pace to the starting point for the escape. The handler heels his/her dog to the marked position for the escape.

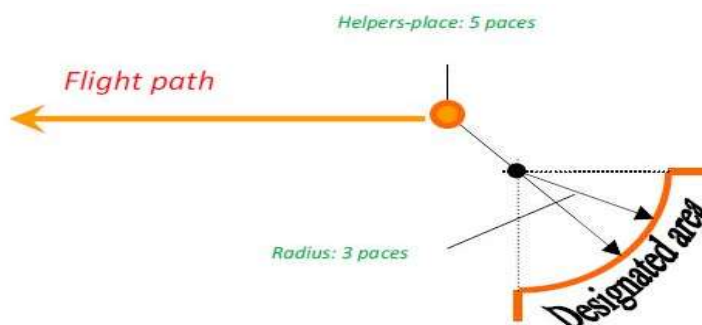

**FCI-IGP-1**

The dog is either heeled on leash or off leash to the designated starting position for the escape. The dog must be under control, attentive and concentrated, as well as in the correct position at the knee of the handler. In the basic position, if the exercise is shown on leash, the leash is removed and then the dog is given the command to down. At the command the dog must lie down directly and quickly and must be calm, confident, and attentive to the helper. The distance between the helper and the dog is 5 paces. The handler returns to the blind and remains there with a view of the dog and the judge. The judge signals the helper to escape and the handler commands the dog to "go".

**FCI-IGP-2 and FCI-IGP-3**

The dog must be heeled to the designated starting position for the escape and must take a basic position there. The dog must be under control, attentive and concentrated, as well as in the correct position at the knee of the handler. At the command the dog must lie down directly and quickly and must be calm, confident, and attentive to the helper. The distance between the helper and dog is 5 paces. The handler goes back to the blind and remains there with a view on the dog and judge. The judge signals the helper to escape, and the handler commands the dog to "go".

**Attempted escape: (FCI-IGP-1 – FCI-IGP-3)**

At the judge's instruction, the helper attempts to escape. At the same time the handler gives a command ("go") for the dog to prevent the escape. The dog must without hesitation try to prevent the attempted escape with high determination, attempting to slow or control the helper with an explosive and powerful attack. From the lockup of the helper to the out, the transitional phase is about 1 sec. After a transitional phase, the dog must out (let go). The handler may give a command to out within an appropriate time (about 3 seconds). The subsequent guarding phase before the defense is approximately 5 seconds.

**Evaluation criteria: (FCI-IGP-1 – FCI-IGP-3)**

**Primary are:** Consistent prevention of escape, full firm grip, direct out and a self-assured dominant guarding.

**Secondary are:** Free heeling to and assuming the down position.

**Faults include:** not correct heeling, no resolute prevention of the escape, bad grip, failure in the guarding phase, bothering the helper.

**Further evaluation points:**

If the dog lies down over the marker, this position is maintained, and a partial score is given. If the dog leaves the down position before the helper begins the escape and bites the sleeve, the dog is disqualified. If the dog does not bite, the handler may step to the marker for the down position and call the dog to him/her with a single command and bring it back to the down position and then return to the blind. If the dog then remains in the down position, the work may be continued, and the exercise is "insufficient" and given 0 points. If the dog leaves the position again, it is disqualified for disobedience.

The dog does not react with a firm, fast, energetic and powerful grip and engagement and/or effective prevention of the escape. The dog does not remain quiet, calm and/or full on the grip until the release, not attentive, not dominant or bumping during guarding of the helper; these result in point deductions.

If no command to start the preventing of the escape is given, the exercise is rated one category lower.

If the dog remains in the down position, or if the helper is not caught within 20 paces, protection must be terminated.

**Defense of an attack from the guarding phase: (FCI-IGP-1 – FCI-IGP-3)**

**Commands:** One command for outing and 1 command for the basic position.

After approx. 5 seconds, the helper attacks the dog. The dog must defend itself without the influence of the handler with an explosive and powerful strike and a firm and calm grip. The dog is to be pressured in the drive with stick threats by the helper. Particular attention must be paid to the dog's self-assurance, power, and a full, calm grip. At the order of the judge, the helper stops the drive and pressure. After the helper has locked up, the transition phase must be shown for approximately 1 sec after the helper has stopped. After the transition phase, the dog must release (out). The handler can give a command for the out in an appropriate time (1-3 seconds) on his/her own, additional commands to out will be directed by the judge. During and after the release (out) the helper must stand still. After the out, the dog must guard the helper with attention, confidence, and high dominance.

**Evaluation criteria:**

**Primary elements:** Powerful and confident reaction to the attack of the helper, full, firm and calm grip and self-confidence of the dog, direct separation, powerful and confident guarding.

**Secondary elements:** Assumption of the final basic position

**Faults include:** The dog does not react with firm, fast, energetic, and powerful engagement and/or effective prevention of the attack. The dog is not quiet, calm and/or full on the grip until the release. The dog bumps or is not attentive and dominant during guarding of the helper; these are deducted accordingly.

**End of the exercise in all levels:** The handler follows the judge's instructions to directly approach the dog in a normal gait, the handler stands next to his/her dog and commands the dog into the basic position with a command for "sit". The padded stick is not taken from the helper.

**Back Transport FCI-IGP-2**

**Commands for the transport: "Heel" or "Transport".**

The exercise begins with the end of the exercise "defense against an attack from the guarding phase". The transport is carried out over a distance of 30 paces. A corner is not mandatory. The judge determines the course of the transport. The handler asks the helper to step back 8 paces and turn around. The handler instructs the helper with the command to "transport" and follows him/her with his/her dog, which is intensively attentive to the helper, at a distance of about 8 paces. This distance must be maintained during the entire back transport. On the order of the judge, the helper stops and stands still. The handler goes to the helper with his/her dog who is attentive to the helper, stands beside the helper and takes the padded stick. The dog must sit in the basic position. Thereafter, a side transport to the judge is shown over a distance of about 20 paces. A command for the transport is allowed. The dog must be between the helper and the handler. The dog must be attentive to the helper. However, the dog is not allowed to press, bump or grip the helper. At the end of the transport, the handler takes a basic position with his dog in front of the judge, hands over the padded stick to the judge and announces the first part of protection is completed.

If the dog bites the sleeve while the helper is stepping back, the handler may bring the dog under control with a command "out"/ "heel" to assume the basic position. If the dog obeys, the entire exercise is assessed as "insufficient" with minus 3 points and the exercise can be continued. If the dog does not obey the command, protection must be terminated, and the dog is to be disqualified.

If the dog leaves the position between the helper and handler the transport must stop and the handler has 2 commands to get the dog back to position between the handler and helper so the transport may continue. The deduction for the first additional command is -1,5 points and for the second -2,5 points. If the dog does not obey, the protection work must be terminated and the dog is to be disqualified.

If the dog bites the sleeve during the side transport to the Judge, the handler has a one-time only change to get the dog back under control and in the correct position with the command "out / " here heel" and the entire exercise is to be awarded with "insufficient" and the protection can be continued. If the dog does not obey, the protection must be terminated and the dog is to be disqualified.

**Back transport FCI-IGP-3. Commands for the Transport: "Heel" or "transport".**

The exercise begins with the end of the exercise "defense against an attack from the guarding phase". The transport is carried out over a distance of 30 paces. A corner is not mandatory. The judge determines the course of the transport. The handler asks the helper to step back 8 paces and turn around. The helper is then asked to go ahead and the handler follows him with his dog, who pays close attention to the helper, at a distance of about 8 paces. This distance must be maintained during the entire back transport. The backtransport ends with the beginning of the exercise „Attack on the dog from the backtransport“.

**Evaluation criteria:****Primary Elements:**

Keeping the correct position at the handler and paying attention to the helper.

**Secondary Elements:**

Assume and maintain the basic position.

**Faults include:**

Among other things, the following are incorrect:

Avoidant, unfree behavior, lack of attention to the helper, bouncing forward or lagging behind, dog handler aids, incorrect basic position, incorrect distance to the helper.

Further review notes:





If the dog bites the protective arm while the helper is stepping back, the handler may bring the dog into the basic position with the verbal commands "Out" and "Here-Heel". If the dog obeys, the entire exercise is to be evaluated with "insufficient" and minus 3 points. The exercise back transport may be continued. If the dog does not obey the handler, it will be disqualified for disobedience.

If the dog leaves the handler during the back transport and can be called back on a one-time verbal command, the exercise will be rated "insufficient" and 0 points and the transport can be continued. If the dog bites the protective arm, the dog must be disqualified.

### **Attack on the dog from the back transport. FCI-IGP-3 only**

**Commands:** 1 command for outing and 1 command for the basic position

During the back transport, at the instruction of the judge, the helper turns and attacks the dog. Without intervention by the handler and without hesitation, the dog must engage the helper with a confident, powerful attack with a full firm and calm grip. After the grip the dog is to be pressured by being driven and threatened by the helper. Particular attention must be paid to the dog's self-assurance, powerful and a full, calm grip. At the order of the judge, the helper stops the drive and pressure. After the helper has locked up, the transition phase must be shown for approximately 1 second. After the transition phase the dog must release (out). The handler can independently give a command for the out in an appropriate time. During and after the release the helper must stand still. After the out the dog must guard the helper powerful, attentive, confidence and with high dominance. On the judge's instructions the handler goes to the helper with his dog who is attentive to the helper, with a verbal command for "sit" the dog stops barking. Hereafter the handler and the free heeling dog goes stand beside the helper and takes the padded stick. The dog must sit in the basic position. Thereafter, a side transport to the judge is shown over a distance of about 20 paces. A command for the transport is allowed. The dog must stay between the helper and the handler. The dog must be attentive to the helper. However, he/she is not allowed to press, bump or grip the helper. If the dog leaves the position between the helper and handler the transport must stop and the handler has 2 commands to get the dog back to position between the handler and helper so the transport may continue. The deduction for the first additional command is -3,5 points and for the second -5 points.

If the dog does not obey, the protection must be terminated and the dog must be disqualified. If the dog bites the sleeve during the side transport to the judge, the handler has one chance to get the dog back under control and in the correct position with the command "out" / "here heel" and the entire exercise is "insufficient" and the protection can continue. If the dog does not obey, the protection must be terminated and the dog is to be disqualified. At the end of the transport, the handler takes a basic position with his dog in front of the judge, hands over the padded stick to the judge and announces that the first part of protection is completed.

#### **Evaluation criteria:**

**Primary are:** Confident reaction to the helper's attack. Full, firm and calm grip. Self-confidence and resistance in the pressure phase. Direct, in one move, releasing. Powerful and confident guarding.

**Secondary are:** Whether the dog is guarding in the center or slightly more to the left or right of the helper. The position of the dog during the side transport and assuming the final basic position.

**Faults include:** The dog does not react with a firm, fast, energetic and powerful engagement and/or effective prevention of the attack. Not quiet, calm and/or full on the grip until the release, not attentive, not dominant or bumping during guarding of the helper will deduct the exercise accordingly.

If the dog leaves the helper before the judge has given the command to approach, the protection is terminated. If the dog leaves the helper after the judge has given the order to approach, the exercise is scored as "insufficient".

**Extra evaluation:** If the dog cannot hold the grip but is immediately regripping, the exercise must be extra devaluated with minus 5 points.

#### **Attack on the dog out of motion:**

**Commands:** out, sit and transport

In all levels, the helper yells and threatens the dog. In the levels FCI-IGP1 und FCI-IGP2 before the grip. In level FCI-IGP3, the threatening sounds are given when the helper starts to run towards the handler and the dog and right before the attack of the dog.

#### **FCI IGP-1 with completion of phase C**

Following the exercise "Defence of an attack from the guarding phase", the helper moves away at a normal pace from the dog sitting in the basic position for approx. 20 meters. The dog sitting calmly and attentively to



the helper can be held by the collar. The dog may not be stimulated by the handler. At the order of the judge the helper attacks the dog frontally with yelling and making strong threatening motions. On the judge's instruction, the handler immediately releases his dog with the command to go. The dog must without hesitation attack the helper with high dominance and determination. After the grip the dog is pressured by driving and threats with the padded stick by the helper. Particular attention must be paid to the dog's self-assurance, power, and a full, calm grip. The handler is not allowed to leave his/her place. At the order of the judge the helper stops the drive and pressure and places the back of the dog towards the handler. After the helper has locked up, the transition phase must be shown for approximately 1 second after the helper has stopped. After the transition phase the dog must release. The handler can independently give a command to out in an appropriate time (1 – 3 seconds). Additional commands to out will be instructed by the judge. During and after the out, the helper must stand still. After the out the dog must guard the helper with attention, confidence and high dominance. On the judge's instructions the handler goes to his/her dog, gives a verbal command for the dog to go into the basic position and the handler may put the dog on leash. The padded stick is taken from the helper. The handler may disarm the helper in any way he/she wants as long as the dog and handler remain together during the disarming. Then a new basic position is taken next to the helper for the side transport, either with the dog on leash or off leash, and the transport to the judge takes place over a distance of about 20 paces. A command for heeling or transport is allowed. The dog must remain between helper and the handler. The dog must be attentive to the helper during the transport. The dog is not allowed to press, jump or grip the helper. If the dog leaves the position between the helper and handler the transport must stop and the handler has 2 commands to get the dog back into position between the handler and helper so the transport may continue. The deduction for the first additional command is -3,5 points and for the second -5 points. If the dog does not obey, the protection work must be terminated and the dog is to be disqualified. If the dog bites the sleeve, the handler may give only one command "out/ here /heel". If the dog obeys, the total exercise is awarded "insufficient" and the protection phase can be resumed. If the dog does not obey, the protection phase must be terminated and the dog is to be disqualified. At the end of the transport, the handler takes a basic position in front of the judge, hands the padded stick to the judge and reports that protection is complete. At instruction of the judge, the handler goes with his dog on leash, under control, to the position for the critique.

If the dog leaves the helper before the Judge has given the command to approach, the protection is terminated (0 Points for phase C) If the dog leaves the helper after the Judge has given the order to approach, the exercise is scored as "insufficient"

**Evaluation:**

Primary items are:

Self-confident reaction on the attack of the helper, a full, solid and calm grip. Self-assured and correctness in the pressure phase, correct out, self-assured and dominant guarding.

Secondary items are: taking the basic position.

**Faults include:** Slow reaction on the attack, bad grip, not self-assured and incorrect in the guarding phase, slow outing, bothering the helper, not correct attention during the transport phase, helps of the handler.

**Extra evaluation:** If the dog cannot hold the grip but is immediately regripping, the exercise must be extra devaluated with minus 5 points.

**FCI-IGP-2**

After the "Backtransport" exercise, on instruction from the judge, the handler takes his off leash dog to a marked point about 30 meters away from the helper. The dog must be in the correct heeling position on the knee of the handler. After reaching the marked position for the next exercise, the handler stops and turns around in the direction of the helper. Then the dog is brought into the basic position with the command to sit. The dog, sitting calmly and attentively to the helper, can be held on the collar. The dog may not be stimulated by the handler. At the order of the judge, the helper attacks the dog frontally with yelling and making strong threatening motions. On the judge's instruction, the handler immediately releases his/her dog with the command to go. The dog must without hesitation attack the helper with high dominance and determination. After the grip the dog is to be pressured by driving and threats with the padded stick by the helper. Particular attention must be paid to the dog's self-assurance, power, and a full, calm grip. The handler is not allowed to leave his place. At the order of the judge, the helper stops the drive and pressure and places the back of the dog towards the handler. After the helper has stopped and locked up, the transition phase must be shown for approximately 1 second. After the transition phase the dog must release. The handler can independently give a command for outing after 1-3 seconds. Additional commands to out will be instructed by the judge. During and after the release the helper must stand still. After the out the dog must guard the helper with attention, confidence and high dominance for approximately 5 seconds.

**FCI-IGP-3:**

The handler, after the side transport at the end of the exercise "Attack on the dog from the back transport" and on instruction of the judge, takes his/her free heeling dog to the marked place on the center line even with the first blind. The heeling dog must show stress-free and intense attention to the handler and be straight at the left the knee of the handler. After reaching the position for the attack out of motion the handler stops and turns around. With the command to sit, the dog is brought into the basic position. The straight, quiet and attentive to the helper sitting dog can be held by the collar, but may not be stimulated by the handler. At the order of the judge the helper with a padded stick comes out of a blind and runs to the center line. After reaching the center line the helper turns up field and runs towards the handler and the dog and attacks, without interrupting his running pace, while yelling and making strong threatening motions. As soon as the helper is about 50 meters from the handler and the dog, on the judge's instructions, the handler immediately releases his dog with the command to go. The dog must without hesitation engage the helper with high dominance and determination. After the grip the dog is to be pressured by driving and threats with the padded stick by the helper. Particular attention must be paid to the dog's self-assurance, power, and a full, calm grip. The handler is not allowed to leave his place. At the order of the judge, the helper stops the drive and pressure and places the back of the dog towards the handler. After the helper has stopped and locked up, the transition phase must be shown for approximately 1 second. After the transition phase the dog must release. The handler can give independently a command for the out in an appropriate time (1-3 seconds). Additional out commands will be directed by the judge. During and after the release the helper must stand still. After outing the dog must guard the helper with attention, confidence and high dominance and high dominance for approximately 5 seconds.

**Evaluation criteria:**

**Primary are:** Confident reaction to the helper's attack. Full, firm and calm grip. Resistance in the pressure phase. Direct releasing. Dominant and confident guarding.

**Secondary are:** The position of the dog in the free-heeling to the marked place. The position of the dog at the helper in the guarding phase.

**Faults include:** If the dog is not reacting with a firm, fast, energetic and powerful engagement and/or effective prevention of the attack. Not quiet, calm and/or full grip until the release, not attentive, dominant guarding the helper, this will be deducted accordingly. If the dog leaves the helper protection is terminated.

**Extra evaluation:** If the dog cannot hold the grip but is immediately regripping, the exercise must be extra devaluated with minus 5 points.

**Defence of an attack from the guarding phase, with completion of phase C  
IGP-2 and FCI-IGP-3****FCI-**

**Commands: out, sit and transport:** After the exercise "defense against an attack out of motion", the helper undertakes on the judge's instruction an attack on the dog. The dog must defend itself without the influence of the handler by an explosive and powerful strike. The dog is to be pressured in the drive with stick threats by the helper. Particular attention must be paid to the dog's self-assurance, power, and a full, calm grip. At the order of the judge, the helper stops the drive and pressure. After the helper has stopped and locked up, the transition phase must be shown for approximately 1 second. After the transition phase, the dog must release. The handler can independently give a command for the out in appropriately 1-3 seconds. Additional out commands will be instructed by the judge. During and after the release the helper must stand still. After the out the dog must guard the helper with attention, confidence and high dominance.

On the judge's instructions, the handler goes to his/her dog, and returns the dog into the basic position with the command to sit. The padded stick is taken from the helper. The handler may disarm the helper any way the handler wants as long as the dog and handler remain together during the disarming. A new basic position is then taken by the handler and dog next to the helper. The side transport to the judge over a distance of about 20 paces with the dog off leash must be shown. A command for heeling or transport is allowed. The dog must stay between the helper and the handler. The dog must be attentive to the helper during transport. The dog is not allowed to press, jump or grip the helper. If the dog leaves the position between the helper and handler the transport must stop and the handler has 2 commands to get the dog back into position between the handler and helper so the transport may continue. The deduction for the first additional command is -3,5 points and for the second -5 points. If the dog does not obey, the protection must be terminated and the dog must be disqualified. If the dog bites the sleeve, the handler may give a one additional command "out/ here /heel". If the dog obeys, the total exercise is awarded "insufficient" and the protection phase can be resumed. If the dog does not obey, the protection must be terminated and the dog must be disqualified. At the end of the transport, the handler takes a basic position in front of the judge, hands the padded stick to the judge and reports that protection is completed. The handler must free heel 5



paces away from the judge before taking a basic position and putting the dog on the leash. At the instruction of the judge the handler goes with his dog on leash and under control to the position for the critique.

#### **Evaluation criteria:**

**Primary are:** Confident reaction to the helper's attack. Full, firm and calm grip. Self-confident resistance in the pressure phase. Direct releasing. Dominant and confident guarding.

**Secondary are:** Taking the basic position. The free heeling to the starting point for attack out of motion.

**Faults include:** The position at the helper at the guarding phase. The position of the dog during the side transport and assuming the final basic position.

If the dog is not reacting with firm, fast, energetic and powerful engagement and/or effective prevention of the attack. Not quiet, calm and/or full on the grip until the release, bumping, not attentive, dominant during guarding of the helper, this must be deducted accordingly. If the dog leaves the helper before the judge has given the handler the command to approach, protection is terminated (0 points for phase C). If the dog leaves the helper after the judge has given the order to approach, the exercise is scored as "insufficient".

**Extra evaluation:** If the dog cannot hold the grip but is immediately regripping, the exercise must be extra devaluated with minus 5 points.

#### **Helper regulations**

The helper in phase "C" is the assistant to the judge in phase "C"

The guidelines and regulations of the trial rules regarding help work and the instruction of the judge must be followed. In view of his personal protection as well as due to insurance liability, the helper, whether in training or on a given trial day or competitions, must wear protective clothing, (protection pants, protection jacket, sleeve, cup, and if necessary gloves).

The helper's shoes must be weather-proof and suitable for the ground conditions, secure stance and ensure good traction.

The following points should be noted:

- Prior to the trial work in phase "C", the helper (HL) receives instructions from the judge. He must perform the work in accordance to the judge's instructions.
- The helper must follow the instructions of the handler during disarming of the helper in accordance with the trial rules. He must give the handler the opportunity to position his dog in the correct heel position for the side/back transport.
- In the case of a club trial, it is allowed to work with one helper. A one-time change of the helper is allowed if the helper himself is also a participant in the club trial. For trials on a national level, such as competitions, qualification trials, championships, etc., 2 helpers are generally to be used. All trials can be attended by a helper who lives in the same household as one of the handlers.

#### **Guidelines for the helpers work:**

1. When the dog is subjected to the threat of a stick, the dog is threatened with a stick by the helper without being touched or hit. The threat must be carried out vigorously by the helper.

#### **2. "Hold and bark"**

The helper stands – not visible to the handler and the dog – with his protective arm slightly bent and without a "threatening" posture in the assigned hiding blind. The protective arm serves as body armor. The dog is to be observed by the helper while "Holding and barking". Additional stimuli as well as assistance of any kind are not permitted. The soft stick is held sideways downwards.

#### **3. "Prevention of an attempted escape of the helper"**

After the hold and bark exercise, the handler calls the helper out of the blind, who is to exit in a normal pace and places himself/herself at the designated spot as assigned by the judge (marked spot). The position of the helper must ensure that the handler can place his dog at a distance of 5 paces on the side where the helper's protection sleeve is at the helper's designated spot. The flight path must be clearly recognizable for the handler.

Under the direction of the judge, the helper escapes in a quick and assertive pace in a straight line, without running an uncontrolled or exaggerated manner. The sleeve must remain steady and the dog should be given an optimal grip possibility. The helper may not turn to face the dog at any time, but can keep the dog in his/her field of vision. The helper must refrain from pulling the sleeve away. Once the dog has gripped, the helper continues to run in a straight direction, and while running pulls the sleeve in tight to his/her body.

The judge determines how far the helper needs to escape. Under the direction of the judge, the helper terminates the escape. When the corresponding dynamic work of the helper is carried out, it provides the

judge with the optimal opportunity to evaluate the performance. Any type of helper assistance in the way of, excessive offering the sleeve before the grip, verbal agitation, or hitting the soft stick against his pants before or during the escape, limply held sleeve position, reducing the speed of the escape independent termination of the escape, etc., are not permitted.

#### **4. “Defense against an attack during the guarding phase”**

After the guarding phase, the helper makes an attack on the dog at the instructions of the judge. The soft stick is used in a threatening motion above the sleeve without hitting the dog. At the same moment, the dog grips in a frontal and forward movement with corresponding resistance, without the sleeve being set into motion. The protection sleeve will be carried tight and in front of the body. Once the dog has gripped, he is to be placed out of motion to the side and the pressure phase begins in a straight direction. Turning at the start of this exercise is not permitted. The helper must drive all dogs in the same direction. It is important that the judge must place himself/herself in such a position so as to observe and evaluate the behavior of the dog during the attack, the pressure phase, the grip behavior, the out and the guarding phase. Driving the dog to the handler is not permitted.

The duration of the pressure phase is determined by the judge. Under the direction of the judge, the helper terminates the pressure phase. When the corresponding dynamic work of the helper is carried out, it provides the judge with the optimal opportunity to evaluate the performance. Any assistance given by the helper in the way of offering any type of helper assistance in the way of, offering the sleeve before the grip, verbal agitation, or hitting the soft stick against his pants before or during the escape, limply held sleeve position after the grip during the pressure phase, inconsistent intensity during the pressure phase and independent termination when weakness is determined in the dog etc., are not permitted.

Termination of the exercise – see point 8

#### **5. “Back transport” (FCI-IGP2 und FCI-IGP3)**

Under the direction of the handler, the helper demonstrates a back transport over a distance of approximately 30 paces at a normal pace. The judge determines the course of the transport. The helper may not any sudden moves during the transport. The soft stick and the sleeve are to be carried in such a way that it does not stimulate the dog. The soft stick especially has to be carried out of sight. The helper is to move at the same pace for every dog.

#### **6. “Attack on the dog out of the back transport (FCI-IGP 3)”**

The attack out of the back transport is performed out of motion and under the direction of the judge. The helper performs the attack by making a dynamic left and right turn and running with purpose towards the dog. The soft stick is to be held above the sleeve and swung in a threatening motion. The dog has to be intercepted with a flexible position of the protection sleeve, whereby the helper cannot come to a halt. Upon intercepting the dog, the body should – if possible – turn in order to catch the dog and flow with his body movement. Additional movement of the sleeve is to be avoided. Once the dog grips, the helper places the dog out of motion to the side and the pressure phase is conducted in a straight direction. The helper must drive all dogs in the same direction. It is important that the judge must place himself/herself in such a position so as to observe and evaluate the behavior of the dog during the attack, the pressure phase, the grip behavior, the out and the guarding phase. Driving the dog to the handler is not permitted.

The duration of the pressure phase is determined by the judge. Under the direction of the judge, the helper terminates the pressure phase. When the corresponding dynamic work of the helper is carried out, it provides the judge with the optimal opportunity to evaluate the performance. Any assistance given by the helper in the way of offering Any type of helper assistance in the way of, offering the sleeve before the grip, verbal agitation, or hitting the soft stick against his pants before or during the escape, limply held sleeve position after the grip during the pressure phase, inconsistent intensity during the pressure phase and independent termination when weakness is noticed in the dog etc., are not permitted.

Termination of the exercise – see point 8

#### **7. “Attack on the dog out of motion”:**

##### **FCI-IGP 1.**

Following the exercise "Defending against an attack from the guard phase", the helper moves at a normal pace about 20 meters away from the dog sitting in the basic position.

**FCI-IGP2.** The helper stops where the 1st part was finished. The handler is instructed to take the starting point for the next exercise with his dog.

##### **FCI-IGP3.**



The helper leaves his assigned hiding place on the instruction of the judge and crosses the field to the center line and turns to the handler and dog. Without interrupting the running step, the helper attacks the handler and dog head-on with threatening gestures with the soft stick. Expelling sounds are to be made when the helper begins to run in the direction of the dog and before the bite. The dog must be accepted with an elastic protective arm position depending on the situation. When accepting the dog, a rotation of the body must be carried out – if necessary – in order to absorb the momentum of the dog. The dog must not be walked around under any circumstances. Once the dog has grasped, it must be placed sideways from the movement by the helper and the pressure phase begins in a straight direction. The helper has to drive all dogs in the same direction. Driving in the direction of the handler is not permitted. The duration of the pressure phase is determined by the judge. The helper adjusts the pressure on the instructions of the judge. Any assistance by the helper as well as independent adjustment in the event of deficiencies in the dog's ability to bear weight, etc. are not permitted. Setting see point 8 (applies to all exercises)

#### **8. "Termination of the defense exercise" :**

Once stopping the defense exercise, the helper must minimize the resistance towards the dog, he/she has to reduce the stimulation by definitively not moving the sleeve. The sleeve is not to be carried at a high angle, but will be held in the same position during the previous exercise. The soft stick is held out of sight at the side. No help is to be provided by the helper during the out phase. After the out, the help is to maintain eye contact with the dog, whereby any additional stimulation or help of any kind is not permitted. In order to maintain eye contact to the dog, the helper is allowed to turn for a dog that circles, but without any sudden movements.

#### **9. "Insecurities and failure of the dog"**

A dog that does not grip during a defense exercise, or releases the grip in a pressure phase and outs, must be driven by the helper until the judge terminates the exercise. In such instances, the helper may not give any help to the dog or stop the exercise independently. Dogs that do not release, the helper may not use the soft stick in movement to get him to out. Dogs that have a tendency to leave the helper during the holding phase may not be stimulated by the helper to stay with the helper. In all or parts of any exercise the helper must present himself/herself active or neutral in accordance with the trial rules. If the dog bumps or grips during the holding phase, the helper must avoid making any defensive motions.

## Additional examinations

### Tracking 1 – 3 (FPr 1 – 3)

The tracking examinations in levels 1 to 3 consist only of the "A" phase of the corresponding examination levels of FCI-IGP-1 to 3. It is up to the handler, at which level his dog is presented.

A training title in the sense of the show requirements, the breeding regulations and the "Breed survey" will not be awarded.

Maximum Points	Excellent	Very Good	Good	Satisfactory	Insufficient
100	100 – 96	95 – 90	89 – 80	79 – 70	69 - 0

The tracking examinations do not need to be performed in the order 1 to 3.

### Obedience 1 – 3 (UPr 1 – 3)

The obedience examinations in levels 1 to 3 consist only of the "B" phase of the corresponding examination levels of FCI-IGP-1 to 3. It is up to the handler, at which level his dog is presented.

A training title in the sense of the show requirements, the breeding regulations and the "Breed survey" will not be awarded.

Maximum Points	Excellent	Very Good	Good	Satisfactory	Insufficient
100	100 – 96	95 – 90	89 – 80	79 – 70	69 - 0

The Obedience examinations do not need to be performed in the order 1 to 3.

### Protection 1 – 3 (SPr 1 – 3)

The protection examinations in levels 1 to 3 consist only of the "C" phase of the corresponding examination levels of FCI-IGP-1 to 3. They can be completed to supplement the trial entries if at least four participants in BH-VT /FCI-IGP or FCI-IFH start. It is up to the handler, at which level his dog is presented. A training title in the sense of the show requirements, the breeding regulations and the "Breed survey" will not be awarded.

Note: Protection Only Trials (Only Phase C) are not permitted.

Maximum Points	Excellent	Very Good	Good	Satisfactory	Insufficient
100	100 – 96	95 – 90	89 – 80	79 – 70	69 - 0

The Protection examinations do not need to be performed in the order 1 to 3.

### Working dog test 1 - 3 (GPr 1-3)

The GPr 1 - 3 examinations only consist of phases B and C of the corresponding examination levels of FCI-IGP 1 - 3. It is up to the handler, at which level his dog is presented. Track work is not shown during these examinations.

A training title in the sense of the show requirements, the breeding regulations and the "Breed survey" will not be awarded.

Maximum Points	Excellent	Very Good	Good	Satisfactory	Insufficient
200	200 – 192	191 – 180	179 – 160	159 – 140	139 - 0



## FCI -IGP Tracking dog examinations

### General provisions

	FCI- IFH1	FCI- IFH2	FCI- IFH3
<b>Line length</b>	10 meters	10 meters	10 meters
<b>Track</b>	Own track	Strange track	Strange track
<b>Length</b>	800 steps	1200 steps	1800 steps
<b>Legs</b>	5.	7.	8. One of them as a semicircle with a radius of approx. 30 meters. The entrance and (or) the exit are placed at a corner of approx. 90°.
<b>Corners</b>	4. approx. 90 °	6. The first 5 corners of approx. 90°. The last corner is laid as an acute corner between 30° - 60°.	7. of which 2 acute corners between 30°- 60°.
<b>Distance between the corners</b>	Minimum 50 steps	Minimum 50 steps	Minimum 50 steps
<b>Articles</b>	3 own articles 3x 7 points	4 strange articles 3x 5 points, 1x 6 points	7 strange articles 7x 3 points
<b>Position of the articles</b>	1. After min. 100 steps. 2. On LR instruction 3. At the end. There can be 2 on one leg.	1. After min. 100 steps 2+3 after track sketch 4. At the end. There can be 2 on one leg.	1. After min. 100 steps 2+3 according to track sketch 7 at the end. There can be 2 on one leg.
<b>Articles size</b>	10x2-3x0,5x-1 cm	10 x2-3x 0.5-1 cm	10 x 2-3 x 0.5-1 cm
<b>Age</b>	90 minutes	120 minutes	180 minutes
<b>Working time maximum</b>	30 minutes	30 minutes	45 minutes
<b>Cross-track</b>		30 minutes before working out the track	30 minutes before working out the track
<b>Prerequisite</b>	FCI BH/VT/ or National BH/VT	FCI-IGP-FH 1	FCI-IGP-FH2

### FCI-IGP-FH

The FCI-IGP-FH is offered as the most difficult tracking test. In this level, one FCI-IFH3 must be completed on each of 2 days. The terrain must be in different fields and the tracks must be laid by different track layers. In order to pass, at least a satisfactory result must be achieved in both tracks. For award placements, in case of equality of total points, the higher single track is valid. If these are also equal, the same placings will be





awarded.

### **Trackable ground**

All natural ground such as meadow, field and forest ground can be used for tracking. In all test levels, changing terrain and path crossings are also possible in adaptation to the existing track terrain.

### **Laying the track**

An FCI-IFH 1 track is laid by the handler. The handler must lay the track according to the instructions of the judge or an appointed tracking coordinator.

For the FCI-IFH 2 and FCI-IFH 3 level, the track must be laid by a stranger and it is advisable for a qualified track layer to determine the course of the track in relation to the existing terrain and to make a drawing of the track for the judge. This drawing includes terrain features (e.g. trees, wire poles, huts, etc.), the number of paces for each track and the location of any articles. The judge/tracking coordinator supervises the laying of the tracks and instructs the tracklayers. The tracks must be laid differently. Corners and articles may not be in the same place or at the same distances on every track. The beginning of the track is to be marked by a departure sign or start flag placed in the ground directly to the left of the scent pad. The tracklayer stops briefly at the beginning of the track and then walks at a natural pace with normal steps in the direction indicated. When laying the track, it must be laid at a natural gait. The corners are also to be laid in normal gait, where a continuous search work must be possible. (No track breaks, see sketch on page...):

Unnatural gait, pawing or stamping by the tracklayer is not permitted anywhere on the track. Articles may not be placed within 20 paces before or after the corners and must lie in the track. The articles must be placed on the track while walking. After placing the last article, the tracklayer must walk at least another 10 paces in a straight line.

In all levels where the track is not laid by the handler, the handler and dog are not allowed to watch the laying of the track.

In the presence of the judge or a person appointed by him/her the order of the participants in the tracking work is determined by drawing lots after the tracks/cross tracks have been laid.

### **Cross tracks in FCI-IFH2 and FCI-IFH3 levels**

The cross track shall not be laid within 40 paces before or 40 paces after a corner, or across the first or last leg. It must be laid so that the track is not crossed below a 60-degree angle and may not cross a leg of the track twice. The distance from the track for the cross tracklayer before laying the cross track, is at least 10 meters. The dog is allowed to check cross tracks without any deduction if it does not leave the actual track. If the dog changes from the track to the cross track and follows this cross track more than one leash length, the track must be terminated. The judge must terminate the trackwork at the moment the handler is at a maximum of 2 paces on the cross track.

### **Instruction**

The handler is allowed to ask the judge to briefly interrupt the trackwork if he believes that he/she or his/her dog needs a short break due to physical condition and/or weather conditions (e.g. high heat). The pause will be counted towards the available time to work out the track. The handler is allowed to clean his/hers and/or the dogs head, eyes and nose or let the dog drink a bit of water during the break or while at an article. For this purpose, the handler can carry some water, a wet cloth, or a wet sponge. The water, cloth or sponge must be shown to the judge before the start of the track.

**No other motivation tools are allowed.**

### **Articles**

Articles must not be placed within 20 paces before or 20 paces after a corner and must not differ significantly in color from the terrain. The article must be placed between the footsteps or alternatively, if the terrain requires it, in the footsteps. The article must be shown by the tracklayer to the judge or track supervisor before the track is laid. Only articles which the tracklayer has carried in his/her pocket for at least 30 minutes may be used. Within a track the articles must consist of different materials (e.g. leather, textiles, wood). In FCI-FH Championships the objects must be numbered. These numbers must correspond to the track number and must be placed in order on the track.

If an article is not indicated by the dog and cannot be found by the tracklayer, no points will be deducted. In the event that several articles are not found, the handler will be offered a substitute track. If the handler does not accept this, the articles not found are considered to have been passed over. This rule does not apply to FCI-IFH1, where the handler is the tracklayer. In these cases when an article is not indicated by the dog, no points will be awarded for these articles.

**Indicating of the articles**

Indicating can be done sitting, laying down or standing up, alternating on one track is permitted. Alternatively, the dog can also pick up or retrieve the article. After picking up the article the dog may remain standing, sit down or bring the object to the handler. Picking up the articles and laying down is faulty, as is continuing to walk with the article.

If the dog retrieves the article, the handler must drop the leash and remain at his/hers place at the end of the leash from the time the dog picks up the article until the dog presents the article. The dog must retrieve the article in a direct way and can sit or stay in front of the handler while presenting the article, the handler collects the article (with the command for letting out) and restarts the dog to track from this place while standing in front/ just behind or next to his/her dog.

The articles must be indicated directly and convincingly, stress-free and confidently, without the help of the handler. When the dog has indicated or picked up the article in a permitted position (standing, sitting, lying), the handler drops or lays down the tracking leash, goes directly to the dog, picks up the article or, if the dog picks up/retrieves it, takes it from the dog and shows it to the judge. This may be done on the dog's left or right side. These procedures are done without judge's instruction.

The indication must be done in the direction of the track. Slightly crooked (+/-30 degrees) laying down, sitting or standing to the object is not faulty.

It is also not faulty if the dog remains in its position and looks in the direction of the handler. For a good indication, the object must be directly in front of or between the front paws. It is not necessary for the dog to fixate (stare) at the article. The dog must remain calm and without stress or avoidance signals in its position until it is given the command to track. Articles found with strong assistance from the handler are considered to have been missed.

After the article has been shown to the judge, a restart is made with a command to track. The restart is done without the judge's instruction. The handler stands directly next to or behind the dog.

**Sketch for evaluating the articles**

**A= Direction of the track.**

**B= 2nd part of the body of the dog**

Distance between the paws and the objects 8 and 9 maximum 20 cm

The sketch serves as a rough orientation. The following factors must be taken into account in the assessment:

- Wind conditions
- Size of the dog
- Position of referencing (sitting, lying, standing)

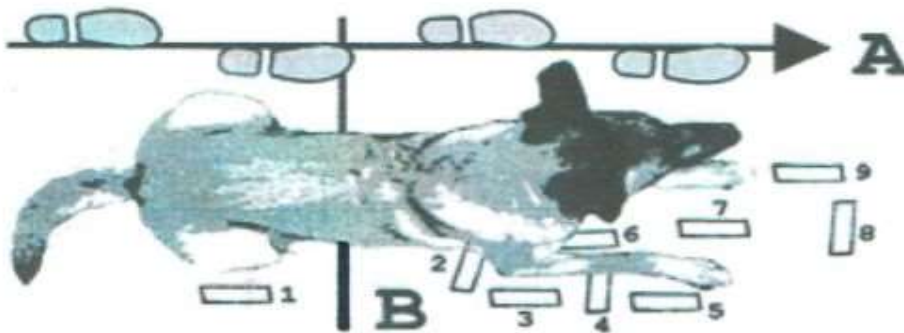

**Allocation of points for the articles** Insufficient= Ins., Sat.=satisfactory, G=good, VG=very good, Ex.=excellent

	Max.	No. 1	No. 2	No.3	No.4	No.5	No.6	No.7	No.8	No.9
		Ins.	Sati.	G	G	VG	VG	Exc	Ex/ VG	Ex/ VG
FCI-IGP-IFH 1	7 points	4	5	5,5	5,5	6,5	6,5	7	6,5	6,5



FCI-IGP-IFH-2	3x5 points +1x6 points	3	3,5	4	4	4,5	4,5	6 (5)	4,5-4,75	4,5-4,75
		4	4,5	5	5	5,5	5,5	6	5,5-5,75	5,5-5,75
FCI-IGP-FH-3	3 points	1	2,25	2,5	2,5	2,75	2,75	3	2,8	2,8

### Tracking leash

A check of the leash length, the collar, the tracking harness or Bötcher by the Judge or an appointed person, must be carried out before the start of the track work (at the latest, at the time of reporting in). Flexible leashes are not permitted. The tracking leash can be over the back, on the side of the dog or between the front and / or rear legs. It can either be attached directly to the loose-fitting collar or to the attachment ring of the harness (chest or Bötcher harness without additional straps). If a harness is used, make sure that the back strap must not extend beyond the last rib of the dog. The tracking leash may occasionally sag during the track, but the required distance between the handler and the dog must not be seriously shortened. Occasionally ground contact of the leash is not faulty. The handler must follow the dog, holding the end of the leash. It does not matter how the leash is held - with one hand, with two hands, whether he/she will change his hand with the leash, at what height he/she holds the leash, etc., if this is not related to interference in the dog's work. The handler must not affect the dogs work by restrain, changing the tension of the leash or control the dog. For small dogs the prescribed normal loose-fitting collar can be replaced by another suitable collar.

**Free Tracking:** When tracking off leash, the distance of at least of 10 meters between the handler and the dog must be observed.

### Report in/ Report out

When the team has been called, the handler reports in with the dog prepared for tracking. The leash must be extended and if a harness is used it must be on the dog. The dog will be in the basic position in front of the judge and the handler gives his/her name, the dog's name, the level and whether the dog retrieves or indicates the articles. During the report in, the dog is allowed to be on a short leash. The dog is then allowed to be on a short leash up to about 2 meters before the start. All compulsion is to be avoided before and during the entire track. At the instruction of the judge the dog is calmly led to the start of the track (a verbal command to the dog to follow his handler is permitted) and started with a verbal command of the handler to track. A short sit, stand or laying down of the dog in front of the start of the track (approx. 2 meters away) is permitted so the tracking leash can be brought into the position desired by the handler (leash between front and/or rear legs). The dog must be started at the starting flag with a verbal command to track with the handler next to or just behind the dog. After finishing the track, the found articles must be shown to the judge. Playing with or feeding the dog after indicating the last article and before reporting out and receiving the score is not permitted. Reporting out must take place in the basic position. After this, the short leash can be put on the dog.

### Working the Track

The dog must be given a verbal command to track at the starting flag. The handler has a maximum of 3 commands to start his dog. If the dog does not start the track after 3 commands, the tracking must be terminated, and the result is 0 points. The second and third commands lead to a deduction in the evaluation of the first leg. For each extra command there is a mandatory deduction of 1,5 points. If the handler has the impression that the dog has not correctly taken the scent of the track, he/she is free to recall the dog and restart again. This is only possible once and only if the handler has not left the start of the track. This is subject to a mandatory deduction of -4 points.

The dog must start the track with a deep nose and then work the entire track with a deep nose, with self-confident, high tracking intensity, consistent and even speed. It is important for the whole track that the dog is the one that leads and is making the decisions. The search speed is not a faulty criterion if the dog is tracking in a convincing and intensive manner. The start (also when restarting after indicating the articles) must be done with the handler standing upright next to or just behind the dog and with a verbal command to track. The handler must remain stationary until the entire leash is rolled out. The way the handler lengthens (releases) the leash is not important if it does not affect the dog's work. During the track, the handler is allowed to use gloves. A certain amount of slack in the leash is permitted.

The time for preparing the dog and the start of the track is not time-dependent, but the judge must pay



attention to the behavior of the dog at the beginning of the first leg as to how intensely the dog convinces itself to the track and taking the scent. If the dog is tangled in the tracking leash, the handler may ask the judge's permission to untangle the dog. After permission of the judge, the handler stops the dog with a verbal command and goes from the end of the leash to the dog. After the dog is untangled, the handler goes back to the end of the leash and restarts the dog with a verbal command to track, there is no deduction.

### **Corners**

The dog must work out corners confidently and convincingly. Circling at the corner is faulty and lead to deduction. A head check without leaving the track is permitted without deduction. After the corner, the dog must continue with the required high intensity, deep nose and at the same speed. In the corner area the dog handler must maintain the prescribed distance to the dog. However, the handler is not allowed to leave the track until the dog has worked out the corner confidently.

### **Ending the track in all levels**

After the indication of the last article is finished, the dog can be directly taken to the judge to report out; it does not have to be brought into the basic position. The handler with his/her dog on leash does not need to show "heeling on leash" but is free to choose the way of going directly to the judge for reporting out. Reporting out must be done with the dog on leash and in the basic position.

### **Praise/ Encouragement**

Brief praise is only permitted at the article in all FH levels. This can be done before or after picking up and showing the article to the judge, but not both. The handler is not allowed to praise the dog while picking up the tracking leash for the restart.

### **Termination / Disqualification**

If the dog leaves the track and is held back by the handler, the judge must instruct the handler to follow the dog. If the judge's instruction is not followed, the track must be terminated. If the end of the track is not reached within the maximum allowed time the trackwork is terminated by the judge. This does not apply if the dog is on the last leg.

The performance shown until termination is evaluated. If the dog quits tracking (stays in the same place without working, lifting its head, comes back to the handler etc.), the track can be terminated even if the dog is still on the track and the available time for the working the track has not yet expired. If during the trackingwork wild game appears, and the dog follows his hunting instinct, the handler may attempt to prevent the dog from following the wild game by giving the dog the verbal command to down. At the command of the judge, the dog handler calls his dog to him and starts him again with the voice command for "search". If the dog does not continue the track, it is terminated.

### **Termination**

In the case of a termination, all points awarded up to then are awarded. The points reached up to the point of termination are entered in the scorebook.

### **Reasons for termination**

Dog is started on the track 3 x unsuccessfully at the scent pad or after the article indication.

Dog leaves track by more than one leash length, the handler is 2 paces on the cross track, or the handler disregards the Judge's instruction to follow the dog.

Dog is not at the end of the track within the given time.

The dog can no longer be used after it has been distracted by wild animals.

### **Disqualification**

All points awarded up to the point of disqualification (DQ) will be deleted. No points or ratings will be entered into the scorebook. There will not be an evaluation. In the scorebook the reason for the disqualification must be written by the judge.



Reason for disqualification	Consequence
Dog picks up the article on the track and will not or cannot release it (swallowed)  During the free tracking, the dog leaves the track by more than 10 meters and does not return after 3 voice commands.	Disqualification for disobedience
The dog is not neutral during the impartiality check	Disqualification due to lack of impartiality
Unsportsmanlike behavior of the handler (for example, transport of motivation objects and / or food)  Actions against the FCI-IGP regulations, animal protection law or contrary to good manners  Attempt of fraudulent intent by use of prohibited training aids	Disqualification for unsportsmanlike behavior  Disqualification for unsportsmanlike behavior

**Evaluation of the tracking performance:**

A distinction must be made between primary and secondary elements. Primary elements are to be weighted more strongly in order to evaluate the essentials of the tracking work accordingly.

**Primary elements:** Intensity, self-confidence, concentration, direct persuasive referring.

**Secondary elements:** Distance between HF and dog, speed of dropping when referencing.

**Assessment**

The assessment of each leg depends on the length, the terrain, and the weather conditions, and is based on the level at which the dog is tracking. The judge and all accompanying persons may not be in the tracking area where the team has the right to track (10 meters radius around the tracking team and 10 meters distance to the next track). After indicating the article, the handler may approach the dog without the permission from the judge. The judge can, together with the handler, approach the dog, to see the position of the indicated article. The judge must not disturb the dog. After checking the indicated article and before the restart of the dog, the judge must move away again so as not to disturb the restart.

During the whole tracking performance, the dog may not be disturbed by either the tracklayer or the judge. For his/her evaluation, the judge must not only look at the dog or the handler, but must also consider the terrain, the weather, possible distractions, and the time. The judge must base his/her assessment on the total of all influencing variables. The assessment is to be carried out considering the following criteria.

**Tracking**

- Motivated behavior of the dog with a deep nose, constant intensity, and consistent speed before and after the corners, as well as before and after indicating the articles.
- Training level of the dog, (hectic approach, stressed behavior, avoidance behavior are unwanted).
- Cooperation between handler and dog
- Handler carrying aids that are not permitted.
- Difficulties in working out the tracks:
- Tracking conditions such as: vegetation, soil, terrain changes, manure.

- Wild game
- Weather conditions: wind, heat, cold, rain, snow.
- Weather changes

The judge must assess the desire, confidence, working temperament, sureness or uncertainty, stress, or avoidance behavior of the dog in his/her work.

#### Deductions for all examination levels:

- If the handler gives the verbal command to start before the flag a deduction of – 1 points. In this case the dog was started without a command at the starting flag. If the dog start sniffing before the flag without a verbal command of the handler, this is not faulty
- A dog that starts searching without a command before the starting flag will not be deducted as if it is stopped at the starting flag and started with a verbal command to start tracking.
- If the dog stops tracking by falsely indicating an article and the handler does not go to the dog but gives an extra command at the end of the tracking leash “Such”, “Track”, “Find”, etc. there will be a deduction of -1 points at all FCI-IFH levels.
- If the dog stops tracking by falsely indicating an article and the handler does go to the dog and gives the tracking command next to the dog „Such”, “Track:”, “Find”, etc.. there will be a deduction of -2 points at all FCI-IFH levels.
- The handler is not allowed to help the dog at the start or restart by indicating the direction of the track. Deduction for this help is -2 points
- Urinating/defecating = - 8 points

#### Track shapes

##### Examples of track shapes FCI-IFH-1

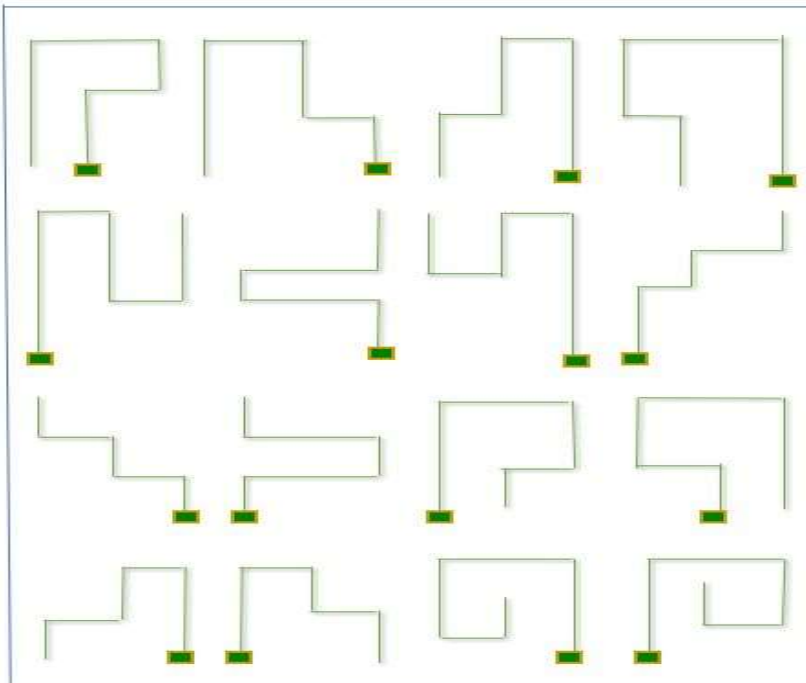

**Examples of track shapes FCI-IFH-2**

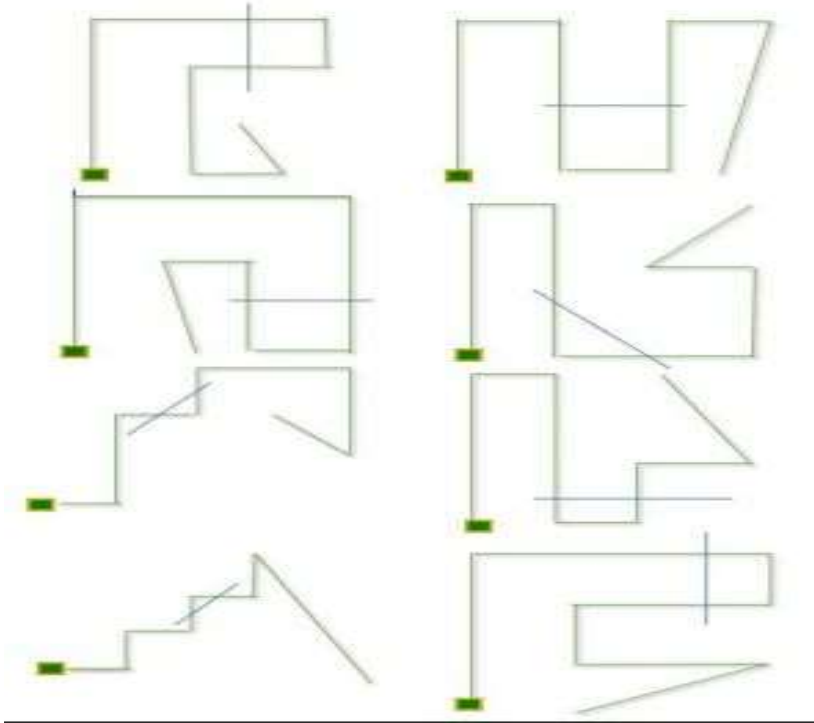

**Examples of track shapes FCI-IFH-3**

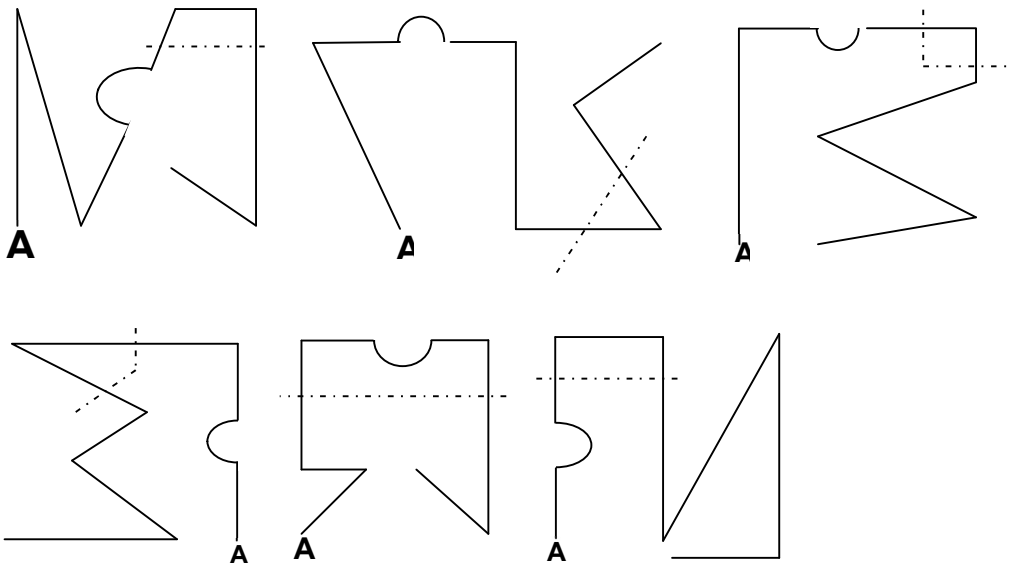

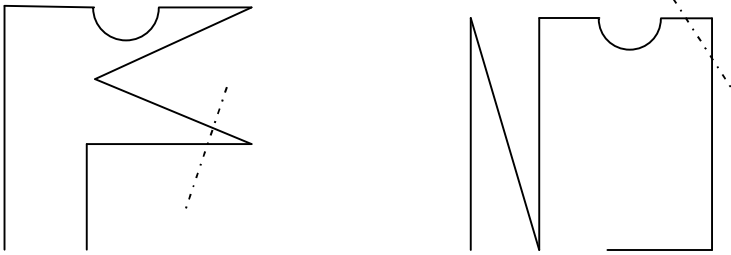

### Laying the corners

#### Corner to the right

#### corner to the left

Winkel rechts

Winkel links

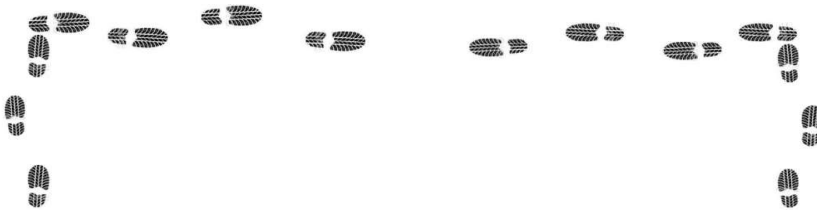

### Laying the articles

(If the vegetation is too high, the objects can also be placed in the footprints).



### Acute corner to the right and to the left

Spitzer Winkel rechts

Spitzer Winkel links



Acute corner; between 30 -60 degrees



**Cross track: crossing at least 40 steps before after the corner. Walking to the crossing point, at least 10 meters from the track.**

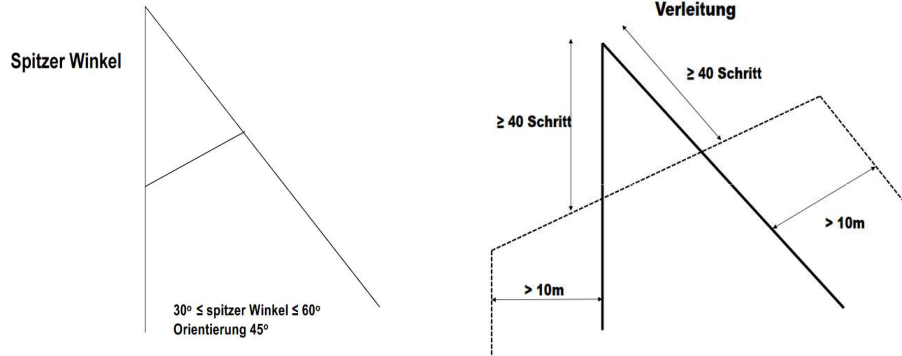

## FCI-Article Search 1-3

### Trial levels for the FCI-Article search

The requirements are set at different levels and reflect the individual testing levels.

Level	Indication Area	Articles	Points	Execution Time
1	<b>20x30 meters</b>	2 handler articles Size: 10 x 3 x 0,5 cm Material = different type <b>1 article left, 1 article right</b>	20 / 20	10 minutes
2	<b>20x40 meters</b>	4 stranger's articles Size: 10 x 3 x 0,5 cm Material = different <b>2 articles left, 2 articles right</b>	10 / 10 / 10 / 10	12 minutes
3	<b>30x50 meters</b>	5 stranger's articles Size: 5 x 3 x 0.5 cm Material: Different <b>Placed at discretion of the judge</b>	8 / 8 / 8 / 8 / 8	15 minutes

### Rating:

The maximum number of points for FCI-Article search 1-3 (FCI-StPr 1 – 3) is 100 points. A minimum of 70 points must be achieved.

### General Requirements:

To take this trial, the dog must be on the day of the examination a minimum of at least 15 months old and must have past successfully the FCI-BH/VT or BH/VT (NPO) test. Females in heat must start as last. Spectators must be at a distance of at least 10 meters.

### Type of area for the search/indication work:

Terrain: all-natural grounds (grass, ploughed field, wooded area). Tree stumps are also permitted. Avoid any opportunity for visual indication, so avoid short grass or other similar areas. The same area must be used for all participants at all levels. The borders of the area must be marked. The person placing the articles must provide the judge with an area drawing showing the approximate locations of the articles.

It is not permitted to place obstacles (branches, boxes or similar) in the search area.

Before the articles are laid out/thrown out, the search area must be criss-crossed by persons several times, so that no "tracks" are left behind when the articles are laid or thrown out. It is permissible to demarcate the search area with marker posts or cones at the corners. The search area may not be demarcated by a fence or similar boundary. There must be a minimum distance of 2 meters to the next boundary on each side of the search area.

### Articles

Material: Wood, leather, artificial leather, textile. Glass or metal articles are not allowed. The articles may not differentiate in color from the terrain.



Prior to laying out/throwing out the articles, the search area must be crossed by at least 2 people several times, so that no one track is indicated. The distance between this two people must be at least 5 meters. On instruction of the judge, the persons stop crossing the area and leave the search area. Thereafter the judge or an article layer under the instruction of the judge enters the search area and places the articles by laying or throwing. The distance between the articles must be at least 15 paces. The articles may not be visible. For participants in level 1, the handler gives his/her articles to the judge before the exam, in level 2 and level 3, the organization provides the articles and gives them to the judge in time for the exam. The handler and the dog must remain out of sight while the articles are placed.

### **Reporting in The handler in level 1**

The handler reports in, with the dog on leash, in a sportsmanlike manner to the judge, with his/her name, the dog's name, tells the judge the level of examination he/she and the dog are undertaking, and the way the dog will indicate the articles. Thereafter, the handler hands over the two articles as described for level 1. Then the handler and his/her dog must go out of sight and remain there until called for the execution of the exam. After the judge or article layer has placed the articles in the search area, the judge will call the handler and the dog for starting the examination. In level 1 there must be one article placed on the right side and one article on the left side of the search area. There is no further waiting time to begin. The examination may begin immediately after the articles are placed.

### **The handlers in level 2 and 3**

The handler reports in, with the dog on leash, in a sportsmanlike manner to the Judge, with his/her name and the dog's name and reports the Judge the level of examination he/she and the dog are undertaking and the way of indicating the dog will show.

After the article layer has placed the articles in the search area, the judge will call the handler with the dog for starting the trial. In level 2 and level 3 the articles are to be evenly divided over the right and left sides of the search area.

### **Execution of the trial in all levels**

After instruction by the judge, the handler is free to choose the side of the test area as starting point for the examination. After choosing the starting side, the dog handler goes with the dog on leash to the middle of the designated side line he/she will start from and assumes the basic position. In the basic position, the dog is taken off leash. The dog handler must keep the leash with him. It can be hidden in his/her pocket or across the shoulder with the clip to the opposite side of the dog. Any form of force or punishment is to be avoided and will lead to point deduction.

The handler starts the search work by giving the dog a verbal command and at the same time a hand signal for the direction he/she want the dog to search. The dog handler is allowed to go up the imaginary center line to the end and return on the same center line to the chosen start line as many times he/she wishes within the given time. The dog handler may only leave this imaginary center line to collect the indicated articles. If the dog retrieves the articles, the dog handler must remain on the imaginary center line. During the time given for the level the dog is examined, the dog may be sent and guided as frequently as the handler wants by hand signals to the right and left side of the imaginary center line as much as the handler wants.

### **Behavior at the articles**

Articles must be convincingly indicated, picked up or retrieved by the dog. The articles may be indicated by sitting, standing, lying down or in varying styles in the same track. If the dog is picks up the article, it may sit, stand, or retrieve. Laying down or moving forward with the article is faulty. If the dog has indicated an article, the dog handler gives a signal to the judge that the dog has made an indication. After approval of the judge the handler goes to the dog, and after collecting the article, shows the article to the judge by raising it. The judge confirms that he/she has seen the article. Hereafter the handler must return with the dog to the center line and from there the handler must restart the dog with a verbal command for searching and a hand signal for the direction the handler wants the dog to search for the remaining article(s). The dog's position for indicating the articles is not stipulated. However, the located article must be in the immediate area, up to 20 cm, of the dog's front paws. If the dog is indicating the article, the handler must always approach the dog from the side and may not stand in front of the dog. Brief praising the dog after the article is indicated or presented is permitted.

After finding all articles in the given search time, the handler puts the dog on leash, goes in a normal gait to the judge and reports that the search work is completed and shows the articles to the judge. The report out must be done in the basic position. If the search time is reached and not all articles are indicated and found by the dog, the judge will give a signal to the handler to stop the search work. After this signal, the handler calls the dog, put it on leash and goes in a normal gait to the judge to report out and show the found articles. The report out must be done in the basic position in front of the judge.

**Evaluation criteria for all 3 levels:**

The dog's tenacity (Following the instructions/ hand signals of the handler)	20 points.
The dog's intensity of work (determination and work ethic)	20 points
Stamina (never stopping the search drive until the article is found)	10 points.
Behavior of the handler (affecting the dog positively)	10 points
Finding the articles (convincing, confident, steady indication)	40 points

Maximum Points	Excellent	Very Good	Good	Satisfactory	Insufficient
100	100 – 96	95 – 90	89 – 80	79 – 70	69 - 0

To achieve the trial objective, at least 70 points (satisfactory) must be achieved.

**Primary issues are:**

- Consistent, quiet, and fluent working without stress or anxiety,
- Quick release from the dog handler,
- Immediate response to verbal commands and hand signals,
- Persistent and purposeful working of the dog,
- Wide side impacts of the dog.

**Secondary issues are**

Working with a "high nose". Searching with a "high nose" (is not faulty).  
Slightly going out of the boundaries of the search area. (is not faulty).

**Faults include**

Indicating and touching the article	1 - 3 points deduction
Dropping the article during the retrieve	1 - 3 points deduction
Premature breaking indication position,	1 - 3 points deduction
Dog handler leaves the imaginary center line	2 - 5 points deduction
Mice catching, urinating, or defecating, etc.	4 - 8 points deduction
Wandering, work lacks intensity, focus or determination	4 - 8 points deduction
Dog is refuses to give up the article	Disqualification

Articles which are indicated/ retrieved with strong dog handler help. These articles are considered not found.  
Articles not found are not given points.

Verbal commands to indicate, picking up or retrieve are not permitted and leads to the article being evaluated as "not found" and not given points.

## The endurance trial

### General information

#### Purpose

The endurance test is intended to provide proof that the dog is capable of physical effort without subsequent considerable fatigue. The dog's structure and physical condition must be able to hold up throughout the requirements of the entire examination. The examination places increased demands on the body and internal organs, especially the heart and lungs, but also examines other properties, such as temperament and hardiness. The effortless management of the performance must be seen as proof of the physical health and the presence of the required drives.

Before the test starts, the identity of the dog must be verified by the judge, or someone appointed by the judge.

The same provisions apply to the event approval as for the other examinations determined by the national canine organization (FCI-NCO). The result must be entered in the scorebook, or on the pedigree.

When applying for an event authorization, the organizer accepts the responsibility to carry out the endurance test during the summer months only in the early morning or late afternoon hours. The outside temperature should not exceed 22 degrees Celsius (72 F).

#### Admission of dogs

The minimum required age is 16 months. A maximum of 20 dogs are allowed per day with one judge. If there are more than 20 dogs, then a second judge must be used. For safety reasons, each handler is allowed to show only one dog. The dogs must be fully and well trained. Ill, weak, overheated, pregnant or nursing bitches are not allowed to start. At the beginning of the examination, the dog handler checks in with the judge. The judge must be sure the dog is in good shape. Dogs that appear to be tired or uncomfortable are to be excluded from participation. If a dog shows excessive fatigue symptoms or other impairments during the test, the judge must terminate the examination. All decisions by the judge are not contestable.

#### Rating

Points and ratings are not awarded, only "Passed" or "Not passed".

#### Terrain

The examination will be held on roads and paths of various possible surfaces. For example: asphalt, paved or unpaved streets and paths.

#### Performance of endurance test:

The trial is a distance of 20 kilometers in length at a rate of 12 to 15 kilometers per hour.

#### Running exercise

The handler takes his/ her dog to the starting position for the examination. The dog has to run (according to the traffic regulations) on the right side of the dog handler in a normal trot beside the bike. Avoid having the dog run too fast. The leash must be kept longer so that the dog has the possibility to adapt to any tempo. Connection devices ("Springer") are allowed. Slight pulling on the leash is not faulty, but the dog should not be constantly dragging and choking himself/herself. After the first 8 km (5 miles), a break of 15 minutes is required. During this time the judge must watch the dog for any signs of fatigue. Fatigued dogs shall be terminated from the examination.

After the break, 7 km (4.5 miles) more are to be covered, then a break of 20 minutes.

During this break, the dog is given the opportunity to move freely and without constraint.

Shortly before the return to the final running portion the judge must check the dogs for fatigue or injury to their paws. Fatigued dogs or dogs whose paws are injured must be terminated. After completion of the final running portion, a 15-minute break must be inserted. During the break, the dog must be given the opportunity to move freely and without constraint. The judge must determine whether the dog shows signs of fatigue or injury to the paws.

Judges should accompany the dogs on the bike if possible, if not they must follow in a car. The results must be entered in the scorebook. It is necessary for the handler/dogs to be accompanied by a motor vehicle so that dogs that cannot continue, can be loaded into the motor vehicle and transported back to the start.

Dogs that show exceptional signs of fatigue or are unable to withstand the minimum speed of 12 km/h cannot pass the examination.

## DIAGRAMS

### Hurdle

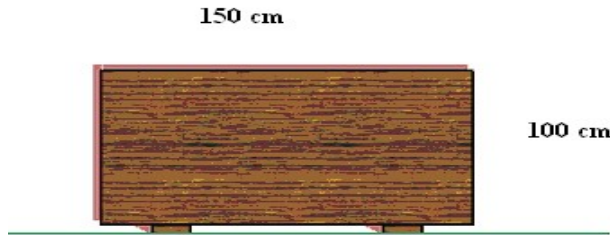

### Scaling wall

The scaling wall consists of 2 sides joined at the top and must be 150 cm wide and 191cm high. At the bottom both sides stand apart so that there is a peak height of 160cm.

The entire area of the scaling wall must be covered with anti-skid material. At the upper part of the sides 3 cleats 24/48mm must be fixed.

All dogs must climbjump the same obstacle.

### Dumbbells for retrieve

	FCI-GP-1	FCI-IGP-2	FCI-IGP-3
<b>On the flat</b>	650 gr	1.000 gr	2.000 gr
<b>Jump</b>	only two jumps	650 gr	650 gr
<b>Scaling wall</b>	only one climbjump	only one (1) climbjump	650 gr

### Dimensions of the Dumbbells

For the retrieve exercises only, dumbbells are allowed. The dumbbells provided by the hosting club/organizer must be used by all participants. Handler's own dumbbells are not permitted except in IBGH-2 and IBGH-3. The sketch of the Dumbbell above is merely a sample. It is important that the weights are correct and that the bars are made of wood and that the bars are at least 4 cm from the ground.

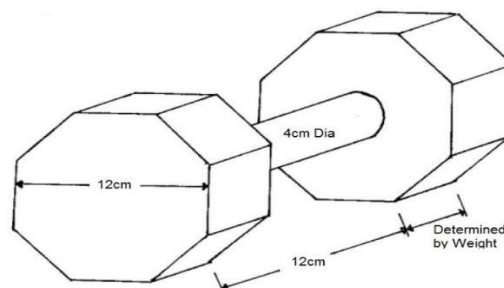

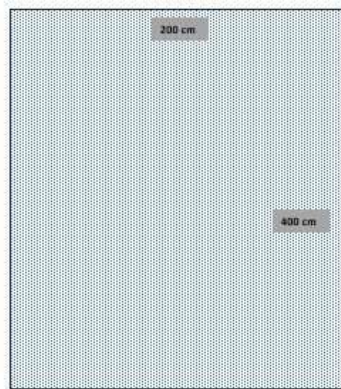

600 cm



400 cm

handler

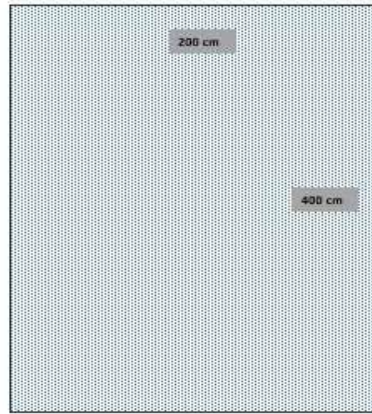

600 cm



400 cm

handler